

Workbenches

bott

Built to Last



Efficient workspace

cubio - Benches



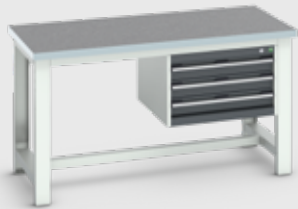

Maximum Stability

With robust construction and up to 1200kg U.D.L total capacity, heavy-duty cubio benches are designed to perform and built to last.

Durable Worktops

Hard-wearing 40mm worktops are used across the range. Choose from Multiplex or Beech, Stainless Steel or Steel Clad, Lino, Phenol, Laminate or ESD Laminate. Custom corner joints, T-joints and special lengths, are available upon request.

Ergonomic Working

Many cubio bench styles offer fixed or height adjustable options and mobile alternatives are available for framework, workstand and storage benches. Rear and overhead frame kits can be used to create efficient and ergonomic workstations including; swivel arms, storage panels, adjustable shelves, service ducts and lighting.

Wide Range of Accessories

Create custom configurations by combining cubio bench systems with our wide range of accessories; including backpanels, base shelves, drawer cabinets and hook and bin kits.

To ensure maximum stability all static cubio benches should be bolted to the floor.

- cubio cabinets
- cubio mobile
- cubio cupboards
- cubio benches
- cubio accessories
- perfo
- CNC
- verso cabinets
- verso mobile
- verso cupboards
- verso benches
- verso accessories
- facilities
- cases
- seating

Worktop Overview



- Heavy duty, 40mm thick worktops
- Wide choice of materials and styles to suit most applications
- Most popular worktop choices are shown with each bench range
- Most worktops are suitable for use with most bench types. Please ask for details if the worktop type required is not shown
- Standard worktops sizes are 750, 1500, and 2000mm wide x 750mm deep and 1500 and 2000mm wide x 900mm deep
- Standard size worktops are shown on page 120 - 121 for customised installations

Beech



40mm beech block.

A high load bearing worktop with good surface resistance to water, oils, acids and chemicals. Suitable for most benching applications.

Multiplex (Mpx)



40mm, resin bonded, layered hardwood beech ply with cross laminated construction.

A tough general duty worktop suitable for most applications.

Phenol **Lino**



40mm top with hardwood core impregnated with phenol resin and edged in hardwood.



40mm overall with a 38mm particle board core and a 2mm grey linoleum surface and a durable plastic edgebanding.

An easy clean top with good surface resistance to water, oils, acids and chemicals.

Steel Clad

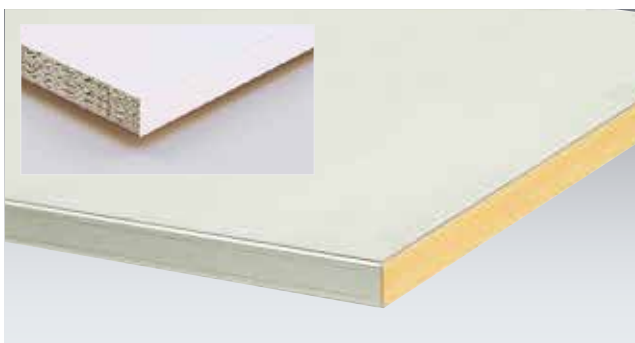

38mm particle board core with 1.2 mm galvanised steel cladding to surface, front and rear edges.

An extremely hard wearing, heavy duty surface for heavy engineering or hot components.

Stainless Clad



38mm particle board core with 1.2 mm stainless steel for the surface and all edges.

Laminate / ESD Laminate



40mm particle board core with grey laminate surface and ABS antistatic edges.

An easy clean top with high abrasion and impact resistance and excellent surface resistance to boiling water, oils, weak acids and chemicals.

The ESD version has conductive core and surface with leakage values in accordance with IEC 61340.

cubio | Benches Framework Benches Fixed Height

Framework Benches

- Heavy duty, braced framework
- Up to 1200kg U.D.L. capacity
- Fixed or adjustable working height
- Choice of 40mm thick worktops
- Mobile models have 125mm diameter castors and 300kg U.D.L. capacity



Basic Bench 840mm High



Length	Depth	Worktop					
		Multiplex	Lino	Laminate	ESD Laminate	Steel clad	Stainless steel clad
		Order Ref.	Order Ref.	Order Ref.	Order Ref.	Order Ref.	Order Ref.
750	750	41003010.16V	41003012.16V	41003629.16V	41003630.16V	41003627.16V	41003628.16V
1500	750	41003082.16V	41003084.16V	41003637.16V	41003638.16V	41003635.16V	41003636.16V
1500	900	41004001.16V	41004021.16V	41004157.16V	41004158.16V	41004155.16V	41004156.16V
2000	750	41003178.16V	41003180.16V	41003645.16V	41003646.16V	41003643.16V	41003644.16V
2000	900	41004003.16V	41004023.16V	41004161.16V	41004162.16V	41004159.16V	41004160.16V

Bench with Half Depth Shelf 840mm High



Model shown in optional .19 colour version

Length	Depth	Worktop					
		Multiplex	Lino	Laminate	ESD Laminate	Steel clad	Stainless steel clad
		Order Ref.	Order Ref.	Order Ref.	Order Ref.	Order Ref.	Order Ref.
1500	750	41003085.16V	41003087.16V	41003653.16V	41003654.16V	41003651.16V	41003652.16V
1500	900	41004017.16V	41004037.16V	41004173.16V	41004174.16V	41004171.16V	41004172.16V
2000	750	41003181.16V	41003183.16V	41003661.16V	41003662.16V	41003659.16V	41003660.16V
2000	900	41004019.16V	41004039.16V	41004177.16V	41004178.16V	41004175.16V	41004176.16V

Bench with Full Depth Shelf 840mm High



Length	Depth	Worktop					
		Multiplex	Lino	Laminate	ESD Laminate	Steel clad	Stainless steel clad
		Order Ref.	Order Ref.	Order Ref.	Order Ref.	Order Ref.	Order Ref.
1500	750	41003503.16V	41003504.16V	41003669.16V	41003670.16V	41003667.16V	41003668.16V
1500	900	41004133.16V	41004134.16V	41004189.16V	41004190.16V	41004187.16V	41004188.16V
2000	750	41003505.16V	41003506.16V	41003673.16V	41003674.16V	41003671.16V	41003672.16V
2000	900	41004135.16V	41004136.16V	41004193.16V	41004194.16V	41004191.16V	41004192.16V

Standard:

.16
RAL 7035 – light grey

Optional:

.19
RAL 7016 – anthracite grey

cupboards

mobile

cupboards

benches

accessories

perfo

CNC

cupboards

mobile

cupboards

benches

accessories

facilities

cases

seating

cubio | Benches Framework Benches Adjustable Height

Basic Bench 740 - 1140mm Adjustable Height



Model shown in optional .19 colour version

Length	Depth	Worktop					
		Multiplex	Lino	Laminate	ESD Laminate	Steel clad	Stainless steel clad
		Order Ref.	Order Ref.	Order Ref.	Order Ref.	Order Ref.	Order Ref.
750	750	41003046.16V	41003048.16V	41003633.16V	41003634.16V	41003631.16V	41003632.16V
1500	750	41003118.16V	41003120.16V	41003641.16V	41003642.16V	41003639.16V	41003640.16V
1500	900	41004125.16V	41004126.16V	41004165.16V	41004166.16V	41004163.16V	41004164.16V
2000	750	41003214.16V	41003216.16V	41003649.16V	41003650.16V	41003647.16V	41003648.16V
2000	900	41004127.16V	41004128.16V	41004169.16V	41004170.16V	41004167.16V	41004168.16V

Bench with Half Depth Shelf 740 - 1140mm Adjustable Height



Length	Depth	Worktop					
		Multiplex	Lino	Laminate	ESD Laminate	Steel clad	Stainless steel clad
		Order Ref.	Order Ref.	Order Ref.	Order Ref.	Order Ref.	Order Ref.
1500	750	41003121.16V	41003123.16V	41003657.16V	41003658.16V	41003655.16V	41003656.16V
1500	900	41004129.16V	41004130.16V	41004181.16V	41004182.16V	41004179.16V	41004180.16V
2000	750	41003217.16V	41003219.16V	41003665.16V	41003666.16V	41003663.16V	41003664.16V
2000	900	41004131.16V	41004132.16V	41004185.16V	41004186.16V	41004183.16V	41004184.16V

Bench with Full Depth Shelf 740 - 1140mm Adjustable Height



Model shown in optional .19 colour version

Length	Depth	Worktop					
		Multiplex	Lino	Laminate	ESD Laminate	Steel clad	Stainless steel clad
		Order Ref.	Order Ref.	Order Ref.	Order Ref.	Order Ref.	Order Ref.
1500	750	41003507.16V	41003508.16V	41003677.16V	41003678.16V	41003675.16V	41003676.16V
1500	900	41004137.16V	41004138.16V	41004197.16V	41004198.16V	41004195.16V	41004196.16V
2000	750	41003509.16V	41003510.16V	41003681.16V	41003682.16V	41003679.16V	41003680.16V
2000	900	41004139.16V	41004140.16V	41004201.16V	41004202.16V	41004199.16V	41004200.16V

Mobile Bench 840 - 1140mm Adjustable Height



Length	Depth	Worktop					
		Multiplex	Lino	Laminate	ESD Laminate	Steel clad	Stainless steel clad
		Order Ref.	Order Ref.	Order Ref.	Order Ref.	Order Ref.	Order Ref.
750	750	41003265.16V	41003267.16V	41003685.16V	41003686.16V	41003683.16V	41003684.16V
1500	750	41003283.16V	41003285.16V	41003689.16V	41003690.16V	41003687.16V	41003688.16V
1500	900	41004141.16V	41004142.16V	41004205.16V	41004206.16V	41004203.16V	41004204.16V
2000	750	41003292.16V	41003294.16V	41003693.16V	41003694.16V	41003691.16V	41003692.16V
2000	900	41004143.16V	41004144.16V	41004209.16V	41004210.16V	41004207.16V	41004208.16V

Standard:

.16
RAL 7035 – light grey

Optional:

.19
RAL 7016 – anthracite grey

cubio
cabinets

cubio
mobile

cubio
cupboards

cubio
benches

cubio
accessories

perfo

CNC

verso
cabinets

verso
mobile

verso
cupboards

verso
benches

verso
accessories

facilities

cases

seating

cubio | Benches Suspended Cabinets

Suspended Cabinets for Framework Benches

On 1500mm and 2000mm wide benches 525mm or 650mm wide cabinets may be used.

Maximum height of cabinets is 600mm for static and 400mm for mobile benches. 750mm deep benches may use either the 525mm deep or 650mm deep cabinets

900mm deep benches may use either the 650mm deep or 750mm deep cabinets.

1500mm wide x 700mm deep lino worktop bench shown in the optional .77 anthracite grey colour.



Suspension Channels

To fix a cabinet to a framework bench a set of suspension channels is required. Choose the correct bench depth, the channels will fit both 650 and 750mm deep cabinets.



To Suit	Order Ref.
750 bench	41010026.16V
900 bench	41010093.16V



650mm Wide x 250mm / 400mm High Cabinets - For all framework benches



A

B

C

Model	Drawers (Qty x Front Height mm) / Cupboard (Height mm)	650mm Deep	750mm Deep
		Order Ref.	Order Ref.
A	1x 150	40019001.19V	40027092.19V
B	2x 150	40019005.19V	40027108.19V
C	3x 100	40019009.19V	40027096.19V

650mm Wide x 600mm High Cabinets - For static framework benches only



D



Model shown in optional .77 colour version



E



F

Model	Drawers (Qty x Front Height mm) / Cupboard (Height mm)	650mm Deep	750mm Deep
		Order Ref.	Order Ref.
D	500 door	40019118.19V	40027098.19V
E	2x 75, 1x 150, 1x 200	40019015.19V	40027100.19V
F	2x 75, 2x 100, 1x 150	40019152.19V	40027102.19V

Housing:

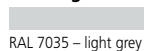

Top, bottom and fronts:

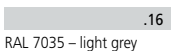
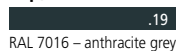

Housing:



Top, bottom and fronts:

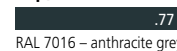

RAL 7035 – light grey

RAL 7016 – anthracite grey

RAL 5010 – gentian blue

RAL 7035 – light grey

RAL 3004 – crimson red

RAL 7016 – anthracite grey

RAL 7016 – anthracite grey

cupio
cabinets

cupio
mobile

cupio
cupboards

cupio
benches

cupio
accessories

perfo

CNC

verso
cabinets

verso
mobile

verso
cupboards

verso
benches

verso
accessories

facilities

cases

seating

cubio | Benches Framework Benches with Suspended Cabinets

750mm x 750mm Workstands with Cabinets



A



B

Model shown in optional .77 colour version



C



D

The cabinets are from the 525mm wide x 650mm deep range. For divider options please see page 131

Model	Height	Cabinet W x D x H	Drawers	Mpx worktop	Lino worktop
				Order Ref.	Order Ref.
A	840	525 x 650 x 250	1x 150	41003521.19V	41003523.19V
B	840	525 x 650 x 400	3x 100	41003524.19V	41003526.19V
C	740 - 1140	525 x 650 x 250	1x 150	41003530.19V	41003532.19V
D	740 - 1140	525 x 650 x 400	3x 100	41003533.19V	41003535.19V
Optional base shelf				41201048.16V	41201048.16V

Mobile 750mm x 750mm Workstands with Cabinets



E



F

Model shown in optional .77 colour version

The cabinets are from the 525mm wide x 650mm deep range. For divider options please see page 131

Model	Height	Cabinet W x D x H	Drawers	Mpx worktop	Lino worktop
				Order Ref.	Order Ref.
E	840 - 1140	525 x 650 x 250	1x 150	41003271.19V	41003273.19V
F	840 - 1140	525 x 650 x 400	3x 100	41003527.19V	41003529.19V
Optional base shelf				41201048.16V	41201048.16V



Housing:

RAL 7035 – light grey

Top, bottom and fronts:

.19
.11
.16
.24

RAL 7016 – anthracite grey RAL 5010 – gentian blue RAL 7035 – light grey RAL 3004 – crimson red

Housing:

RAL 7016 – anthracite grey

Top, bottom and fronts:

.77

RAL 7016 – anthracite grey

- verso cabinets
- verso mobile
- verso cupboards
- verso benches
- verso accessories
- perfo
- CNC
- verso cabinets
- verso mobile
- verso cupboards
- verso benches
- verso accessories
- facilities
- cases
- seating

cubio | Benches Framework Benches with Suspended Cabinets

Framework Benches with Suspended Cabinet



A



A

Model	Width	Depth	Height	Cabinet W x D x H	Drawers	Mpx worktop	Lino worktop
						Order Ref.	Order Ref.
A	1500	750	840	650 x 650 x 250	1x 150	41003396.19V	41003397.19V
	2000	750	840	650 x 650 x 250	1x 150	41003399.19V	41003400.19V
	1500	900	840	650 x 650 x 250	1x 150	41004069.19V	41004070.19V
	2000	900	840	650 x 650 x 250	1x 150	41004072.19V	41004073.19V

Framework Benches with Suspended Cabinet



B



B

Model	Width	Depth	Height	Cabinet W x D x H	Drawers	Mpx worktop	Lino worktop
						Order Ref.	Order Ref.
B	1500	750	840	650 x 650 x 400	3x 100	41003402.19V	41003403.19V
	2000	750	840	650 x 650 x 400	3x 100	41003405.19V	41003406.19V
	1500	900	840	650 x 650 x 400	3x 100	41004075.19V	41004076.19V
	2000	900	840	650 x 650 x 400	3x 100	41004078.19V	41004079.19V

Framework Benches with Suspended Cabinet



C



C

Model shown in optional .77 colour version

Model	Width	Depth	Height	Cabinet W x D x H	Drawers	Mpx worktop	Lino worktop
						Order Ref.	Order Ref.
C	1500	750	840	650 x 650 x 600	2x 75, 1x 150, 1x 200	41003130.19V	41003132.19V
	2000	750	840	650 x 650 x 600	2x 75, 1x 150, 1x 200	41003226.19V	41003228.19V
	1500	900	840	650 x 650 x 600	2x 75, 1x 150, 1x 200	41004009.19V	41004029.19V
	2000	900	840	650 x 650 x 600	2x 75, 1x 150, 1x 200	41004011.19V	41004031.19V



Housing:

RAL 7035 – light grey

Top, bottom and fronts:

RAL 7016 – anthracite grey

RAL 5010 – gentian blue

RAL 7035 – light grey

RAL 3004 – crimson red

Housing:

RAL 7016 – anthracite grey

Top, bottom and fronts:

RAL 7016 – anthracite grey

cupboards

mobile

cupboards

benches

accessories

perfo

CNC

cupboards

mobile

cupboards

benches

accessories

facilities

cases

seating

seating

cubio | Benches Pedestal Benches

Pedestal Benches

- Heavy duty cabinets and support legs
- Up to 1200kg U.D.L. capacity
- Shown with multiplex and lino worktops as standard, the other worktop types are available. Please ask for details.



Multiplex (mpx)

40mm, resin bonded, layered beech ply.
A tough worktop suitable for most applications.

Lino

40mm overall with a 38mm particle board core and a 2mm linoleum surface with a durable plastic edgebanding.
An easy clean, general duty top. Ideal for office, assembly and storage areas.



See page
128



840mm High Benches



Model shown in optional .77 colour version

5 drawer cabinet with 2x 100, 2x 150, 1x 200mm drawers. 650mm wide x 800mm high. 750mm deep benches feature a 650mm deep cabinet, 900mm deep benches use a 750mm deep model

6 drawer cabinet with 2x 75, 2x 100, 1x 150, 1x 200mm drawers. 650mm wide x 800mm high. 750mm deep benches feature a 650mm deep cabinet, 900mm deep benches use a 750mm deep model

Length	Depth	Mpx worktop	Lino worktop
		Order Ref.	Order Ref.
1500	750	41003133.19V	41003135.19V
2000	750	41003229.19V	41003231.19V
1500	900	41004109.19V	41004110.19V
2000	900	41004111.19V	41004112.19V

Length	Depth	Mpx worktop	Lino worktop
		Order Ref.	Order Ref.
1500	750	41003139.19V	41003141.19V
2000	750	41003235.19V	41003237.19V
1500	900	41004113.19V	41004114.19V
2000	900	41004115.19V	41004116.19V

940mm High Benches



6 drawer cabinet with 3x 100, 2x 150, 1x 200mm drawers. 650mm wide x 900mm high. 750mm deep benches feature a 650mm deep cabinet, 900mm deep benches use a 750mm deep model

7 drawer cabinet with 5x 100, 2x 150mm drawers. 650mm wide x 900mm high. 750mm deep benches feature a 650mm deep cabinet, 900mm deep benches use a 750mm deep model

Length	Depth	Mpx worktop	Lino worktop
		Order Ref.	Order Ref.
1500	750	41003492.19V	41003493.19V
2000	750	41003494.19V	41003495.19V
1500	900	41004117.19V	41004118.19V
2000	900	41004119.19V	41004120.19V

Length	Depth	Mpx worktop	Lino worktop
		Order Ref.	Order Ref.
1500	750	41003496.19V	41003497.19V
2000	750	41004121.19V	41004122.19V
1500	900	41003498.19V	41003499.19V
2000	900	41004123.19V	41004124.19V

Housing:

Top, bottom and fronts:

Housing:

Top, bottom and fronts:

- RAL 7035 – light grey
- .19 RAL 7016 – anthracite grey
- .11 RAL 5010 – gentian blue
- .16 RAL 7035 – light grey
- .24 RAL 3004 – crimson red
- .77 RAL 7016 – anthracite grey
- .77 RAL 7016 – anthracite grey

cubio | Benches Island Pedestal Benches

1500mm W x 750mm D x 840mm H

1500mm W x 750mm D x 940mm H



Model shown in optional .77 colour version

cabinets are 525mm wide x 650mm deep x 800mm high

cabinets are 525mm wide x 650mm deep x 900mm high

Drawers / Doors	Mpx worktop Order Ref.	Lino worktop Order Ref.
1x100, 1x175 / 400 door 2x100, 1x200, 1x300	41003695.19V	41003696.19V

Drawers / Doors	Mpx worktop Order Ref.	Lino worktop Order Ref.
1x100, 1x125, 1x 150 / 400 door 3x100, 1x200, 1x300	41003697.19V	41003698.19V

1500mm W x 750mm D x 840mm H

1500mm W x 750mm D x 940mm H



cabinets are 800 / 525mm wide x 650mm deep x 800mm high

cabinets are 800 / 525mm wide x 650mm deep x 900mm high

Drawers / Doors	Mpx worktop Order Ref.	Lino worktop Order Ref.
700 door 2 shelf 2x100, 1x200, 1x300	41003699.19V	41003700.19V

Drawers / Doors	Mpx worktop Order Ref.	Lino worktop Order Ref.
800 door 2 shelf 3x100, 1x200, 1x300	41003701.19V	41003702.19V

2000mm W x 750mm D x 840mm H

2000mm W x 750mm D x 940mm H



cabinets are 650mm wide x 650mm deep x 800mm high

cabinets are 650mm wide x 650mm deep x 900mm high

Model shown in optional .77 colour version

Drawers / Doors	Mpx worktop Order Ref.	Lino worktop Order Ref.
1x100, 1x175 / 400 door 2x100, 1x200, 1x300	41003703.19V	41003704.19V

Drawers / Doors	Mpx worktop Order Ref.	Lino worktop Order Ref.
1x100, 1x125, 1x 150 / 400 door 3x100, 1x200, 1x300	41003705.19V	41003706.19V

2000mm W x 750mm D x 840mm H

2000mm W x 750mm D x 940mm H



cabinets are 650mm wide x 650mm deep x 800mm high

cabinets are 650mm wide x 650mm deep x 900mm high

Drawers / Doors	Mpx worktop Order Ref.	Lino worktop Order Ref.
1x100, 1x175 / 400 door 2x100, 1x200, 1x300 1x100, 1x175 / 400 door	41003707.19V	41003708.19V

Drawers / Doors	Mpx worktop Order Ref.	Lino worktop Order Ref.
1x100, 1x 125, 1x150 / 400 door 3x100, 1x200, 1x300 1x100, 1x 125, 1x150 / 400 door	41003709.19V	41003710.19V

Housing:

Top, bottom and fronts:

Housing:

Top, bottom and fronts:

RAL 7035 – light grey
.19
.11
RAL 7035 – light grey
.16
.24
RAL 7016 – anthracite grey
RAL 7016 – anthracite grey
.77

- cubio cabinets
- cubio mobile
- cubio cupboards
- cubio benches
- cubio accessories
- perfo
- CNC
- verso cabinets
- verso mobile
- verso cupboards
- verso benches
- verso accessories
- facilities
- cases
- seating

cubio | Benches Island Pedestal Benches

1100mm W x 1100mm D x 940mm H



Model shown in optional .77 colour version

Width	Depth	Height	Cabinet W x D x H (mm)	Drawers (Qty x Front Height mm)	Mpx worktop Order Ref.	Lino worktop Order Ref.
1100	1100	940	525 x 525 x 900 (x2) 525 x 525 x 900 (x2)	1x100, 1x125, 1x150 / 400 door (x2) 3x100, 1x200, 1x300 (x2)	41003716.19V	41003713.19V

1350mm W x 1350mm D x 940mm H



Width	Depth	Height	Cabinet W x D x H (mm)	Drawers (Qty x Front Height mm)	Mpx worktop Order Ref.	Lino worktop Order Ref.
1350	1350	940	650 x 650 x 900 (x2) 650 x 650 x 900 (x2)	1x100, 1x125, 1x150 / 400 door (x2) 3x100, 1x200, 1x300 (x2)	41003717.19V	41003714.19V

2500mm W x 2165mm D x 940mm H



Width	Depth	Height	Cabinet W x D x H (mm)	Drawers (Qty x Front Height mm)	Mpx worktop Order Ref.	Lino worktop Order Ref.
2500	2165	940	650 x 650 x 900 (x6)	3x 100, 2x 150, 1x 200 (x6)	41003715.19V	41003718.19V



Housing:

RAL 7035 – light grey

Top, bottom and fronts:

.19
.11
.16
.24

RAL 7016 – anthracite grey RAL 5010 – gentian blue RAL 7035 – light grey RAL 3004 – crimson red

Housing:

RAL 7016 – anthracite grey

Top, bottom and fronts:

.77

RAL 7016 – anthracite grey

- cupboards
- mobile
- cupboards
- benches
- accessories
- perfo
- CNC
- cupboards
- mobile
- cupboards
- benches
- accessories
- facilities
- cases
- seating

cubio | Benches Island Pedestal Benches

1125mm W x 1125mm D x 840mm H



Model shown in optional .77 colour version

Width	Depth	Height	Cabinet W x D x H (mm)	Door height (mm) / shelves	Mpx worktop Order Ref.	Lino worktop Order Ref.
1125	1125	840	525 x 650 x 800 650 x 800 Endframe (x2)	1x 700 door with 1x shelf	41003719.19V	41003711.19V

1125mm W x 1125mm D x 940mm H



Width	Depth	Height	Cabinet W x D x H (mm)	Door height (mm) / shelves	Mpx worktop Order Ref.	Lino worktop Order Ref.
1125	1125	940	525 x 650 x 900 650 x 800 Endframe (x2)	1x 800 door with 1x shelf	41003720.19V	41003712.19V

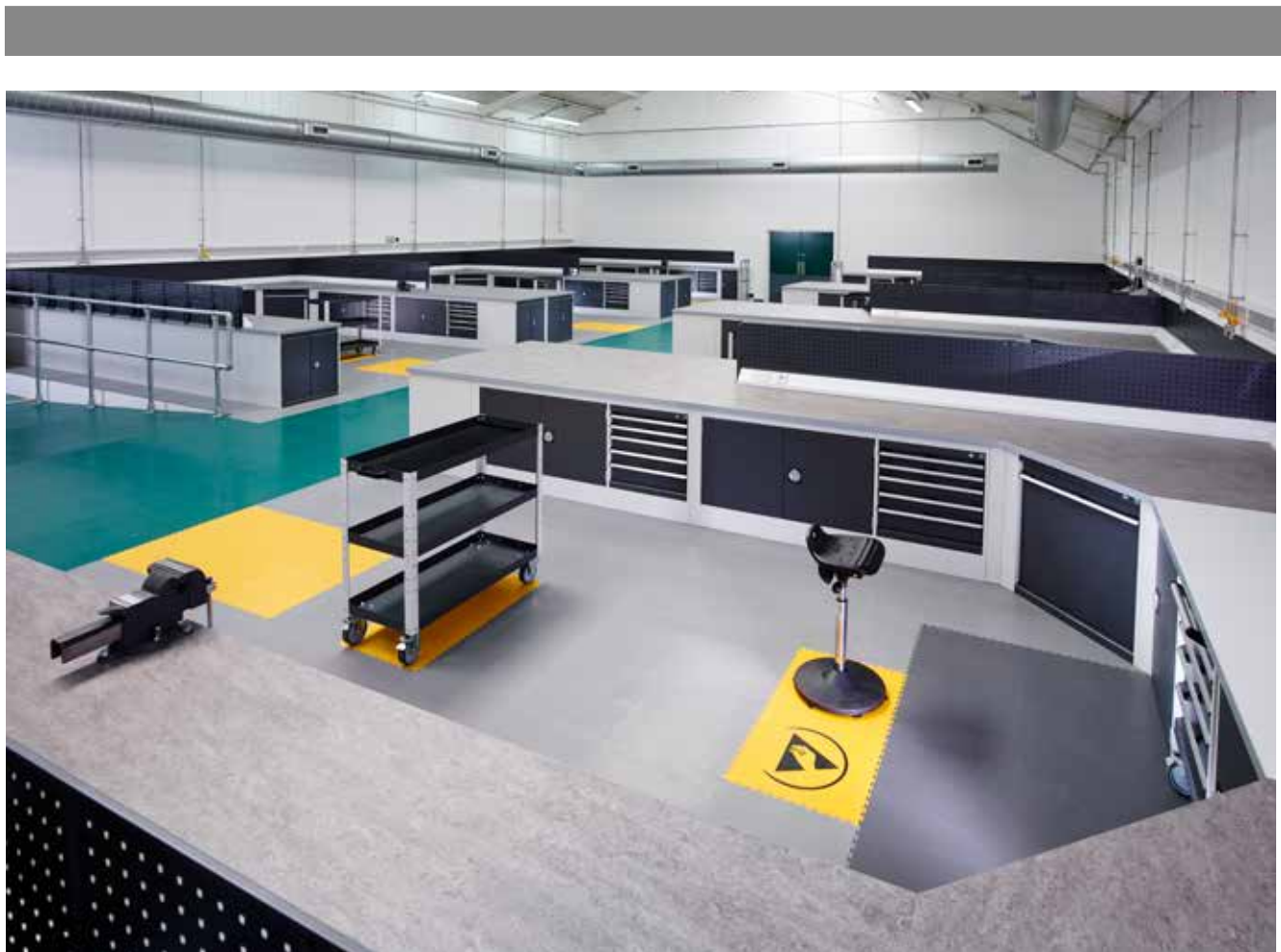

- cupio cabinets
- cupio mobile
- cupio cupboards
- cupio benches
- cupio accessories
- perfo
- CNC
- verso cabinets
- verso mobile
- verso cupboards
- verso benches
- verso accessories
- facilities
- cases
- seating

Accessories

See pages 151 - 157

Cabinets

see pages 30 - 67

Dividers

See page 128

Housing:
 RAL 7035 – light grey

Top, bottom and fronts: .19 .11 .16 .24
 RAL 7016 – anthracite grey RAL 5010 – gentian blue RAL 7035 – light grey RAL 3004 – crimson red

Housing:
 RAL 7016 – anthracite grey

Top, bottom and fronts: .77
 RAL 7016 – anthracite grey

cubio | Benches Storage Benches

Storage Benches

- Storage framework design allows easy cleaning beneath
- Half depth shelf models give knee space for seated work
- Up to 800kg U.D.L. capacity
- Integral cabinets with full extension 75kg U.D.L. capacity drawers
- Mobile models have 125mm castors and 300kg U.D.L. capacity
- Shown with multiplex and lino worktops as standard, the other worktop types are available. Please ask for details.

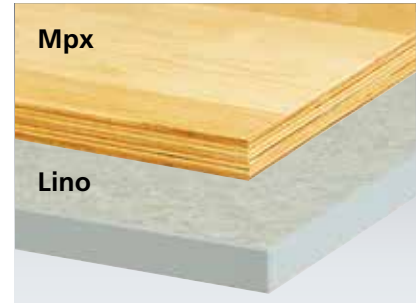

Multiplex (mpx)

40mm, resin bonded, layered beech ply. A tough worktop suitable for most applications.

Lino

40mm overall with a 38mm particle board core and a 2mm linoleum surface with a durable plastic edgebanding. An easy clean, general duty top. Ideal for office, assembly and storage areas.

Adjustable Height Leg Kit



Adjustable height leg set for use with all static storage benches.

Mounts to existing frame with supplied fixings offering height options in 25mm increments from 800 - 900mm or 900 - 1000mm.

Adjustable Leg Kit	
Height (mm)	Order Ref.
840 - 940	41010003.16V
940 - 1040	41010004.16V



See page 128

All models use the 650 x 650 cabinet dividers except 41002169 / 41002170 which use the 1300 x 650 cabinet dividers



750mm Wide x 750mm Deep x 840mm High



A



B



C

Model shown in optional .77 colour version

Model	Drawers / Cupboards	Mpx worktop	Lino worktop
		Order Ref.	Order Ref.
A	500 cupboard with adjustable shelf	41002004.19V	41002006.19V
B	1x 150 drawer, 1x 350 H cupboard	41002007.19V	41002009.19V
C	2x 150, 1x 200 drawers	41002010.19V	41002012.19V

1500mm Wide x 750mm Deep x 840mm High



D



E



F



Model shown in optional .77 colour version

Model	Drawers / Cupboards	Mpx worktop	Lino worktop
		Order Ref.	Order Ref.
D	500 cupboard with adjustable shelf, open section with 1/2 depth base shelf	41002034.19V	41002036.19V
E	1x 150 drawer, 1x 350 cupboard, open section with 1/2 depth base shelf	41002037.19V	41002039.19V
F	2x 150, 1x 200 drawers, open section with 1/2 depth base shelf	41002040.19V	41002042.19V

Housing:



RAL 7035 – light grey

Top, bottom and fronts:

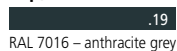

RAL 7016 – anthracite grey



RAL 5010 – gentian blue

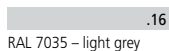

RAL 7035 – light grey



RAL 3004 – crimson red

Housing:



RAL 7016 – anthracite grey

Top, bottom and fronts:

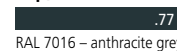

RAL 7016 – anthracite grey

- cupio cabinets
- cupio mobile
- cupio cupboards
- cupio benches
- cupio accessories
- perfo
- CNC
- verso cabinets
- verso mobile
- verso cupboards
- verso benches
- verso accessories
- facilities
- cases
- seating

cubio | Benches Storage Benches

1500mm Wide x 750mm Deep x 840mm High



G



H

Model shown in optional .77 colour version



I



J



K



L



M



Model shown in optional .77 colour version

Model	Drawers / Cupboards	Mpx worktop	Lino worktop
		Order Ref.	Order Ref.
G	500 cupboard with adjustable shelf, open section with adjustable shelf	41002019.19V	41002021.19V
H	2x 150, 1x 200 drawers, open section with adjustable shelf	41002166.19V	41002167.19V
I	2x 500 cupboards each with adjustable shelves	41002022.19V	41002024.19V
J	2x 150 drawers, 2x 350 cupboards	41002028.19V	41002030.19V
K	2x 150, 1x 200 drawers, 500 cupboard with adjustable shelf	41002025.19V	41002027.19V
L	4x 150, 2x 200 drawers	41002031.19V	41002033.19V
M	2x 150, 1x 200 full width drawers	41002169.19V	41002170.19V

2000mm Wide x 750mm Deep x 840mm High



N



O

Model shown in optional .77 colour version



P



Q



R



S



T



U

Model	Drawers / Cupboards	Mpx worktop	Lino worktop
		Order Ref.	Order Ref.
N	2x 500 cupboards each with adjustable shelf, open section with shelf	41002049.19V	41002051.19V
O	2x 150 drawers, 2x 350 cupboards, open section with adjustable shelf	41002052.19V	41002054.19V
P	2x 150, 1x 200 drawers, 1x 500 cupboard, open section with 1/2 depth base shelf	41002070.19V	41002072.19V
Q	3x 150, 1x 200 drawers, 1x 350 cupboard, open section with adjustable shelf	41002058.19V	41002060.19V
R	2x 150, 2x 350 cupboards, open section with 1/2 depth base shelf	41002067.19V	41002069.19V
S	4x 150, 2x 200 drawers, open section with 1/2 depth base shelf	41002073.19V	41002075.19V
T	2x 500 cupboards each with adjustable shelf, 2x 150, 1x 200 drawers	41002055.19V	41002057.19V
U	4x 150, 1x 200 drawers, 2x 350 cupboard	41002064.19V	41002066.19V

Housing:



RAL 7035 – light grey

Top, bottom and fronts:



RAL 7016 – anthracite grey



RAL 5010 – gentian blue



RAL 7035 – light grey



RAL 3004 – crimson red

Housing:

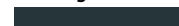

RAL 7016 – anthracite grey

Top, bottom and fronts:



RAL 7016 – anthracite grey

- cupio cabinets
- cupio mobile
- cupio cupboards
- cupio benches
- cupio accessories
- perfo
- CNC
- verso cabinets
- verso mobile
- verso cupboards
- verso benches
- verso accessories
- facilities
- cases
- seating

cubio | Benches Mobile Storage Benches

750mm Wide x 750mm Deep x 840mm High



A



B



C

Model shown in optional .77 colour version

Model	Drawers / Cupboards	Mpx Worktop	Lino Worktop
		Order Ref.	Order Ref.
A	500 cupboard with adjustable shelf	41002085.19V	41002087.19V
B	1x 150 drawer, 1x 350 H cupboard	41002088.19V	41002090.19V
C	2x 150, 1x 200 drawers	41002091.19V	41002093.19V

1500mm Wide x 750mm Deep x 840mm High



D



E



F

Model shown in optional .77 colour version



G



H



I

Model	Drawers / Cupboards	Mpx Worktop	Lino Worktop
		Order Ref.	Order Ref.
D	500 cupboard with adjustable shelf, open section with adjustable shelf	41002094.19V	41002096.19V
E	2x 150, 1x 200 drawers, open section with 1/2 depth base shelf	41002115.19V	41002117.19V
F	2x 500 cupboards each with adjustable shelves	41002097.19V	41002099.19V
G	2x 150 drawers, 2x 350 cupboards	41002103.19V	41002105.19V
H	2x 150, 1x 200 drawers, 500 cupboard with adjustable shelf	41002100.19V	41002102.19V
I	4x 150, 2x 200 drawers	41002106.19V	41002108.19V

2000mm Wide x 750mm Deep x 840mm High



Model shown in optional .77 colour version



Model	Drawers / Cupboards	Mpx Worktop	Lino Worktop
		Order Ref.	Order Ref.
J	2x 500 cupboards each with adjustable shelf, open section with full depth base	41002118.19V	41002120.19V
K	2x 150 drawers, 2x 350 cupboards, open section with adjustable shelf	41002121.19V	41002123.19V
L	3x 150, 1x 200 drawers, 1x 350 cupboard, open section with adjustable shelf	41002127.19V	41002129.19V
M	4x 150, 2x 200 drawers, open section with adjustable shelf	41002130.19V	41002132.19V
N	2x 150, 1x 200 drawers, 2x 500 cupboards each with adjustable shelf	41002124.19V	41002126.19V
O	4x 150, 1x 200 drawers, 2x 350 cupboards	41002133.19V	41002135.19V

Housing:

RAL 7035 – light grey

Top, bottom and fronts:

.19
.11
.16
.24

RAL 7016 – anthracite grey
 RAL 5010 – gentian blue
 RAL 7035 – light grey
 RAL 3004 – crimson red

Housing:

RAL 7016 – anthracite grey

Top, bottom and fronts:

.77

RAL 7016 – anthracite grey

- cupio cabinets
- cupio mobile
- cupio cupboards
- cupio benches
- cupio accessories
- perfo
- CNC
- verso cabinets
- verso mobile
- verso cupboards
- verso benches
- verso accessories
- facilities
- cases
- seating

cubio | Benches Stepless Height Adjustable Benches

Stepless Height Adjustable Benches

- Stepless height adjustment to rapidly achieve perfect working height
- Height range 840mm to 1140mm
- Hydraulic lift mechanism with manual hand crank or electronic activation
- Suitable for use with a 400mm or 250mm high cubio suspended cabinet
- 40mm Multiplex or lino worktop
- Maximum U.D.L capacity 200kg
- Supplied assembled

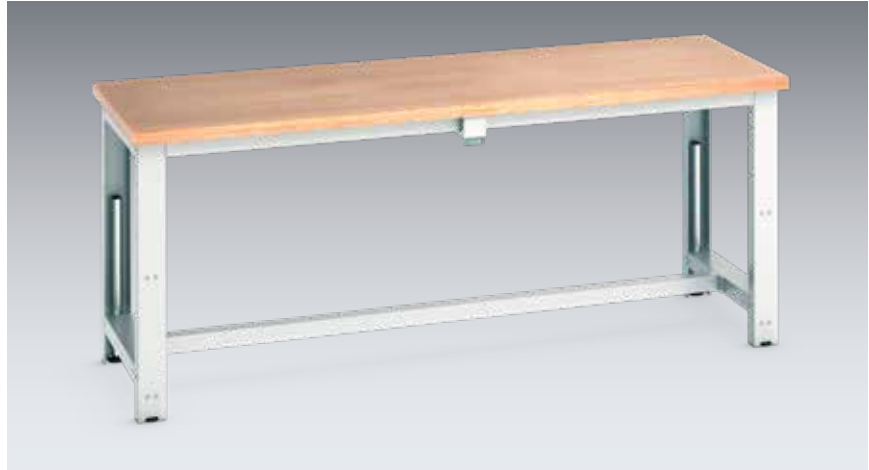

Manual Adjustment



Model shown in optional .19 colour version

Type	Length (mm)	Depth (mm)	Mpx Worktop Order Ref.	Lino Worktop Order Ref.
Manual	1500	750	41003574.16	41003575.16
Manual	2000	750	41003572.16	41003573.16

Electrical Adjustment



Type	Length (mm)	Depth (mm)	Mpx Worktop Order Ref.	Lino Worktop Order Ref.
Electric	1500	750	41003566.16	41003567.16
Electric	2000	750	41003564.16	41003565.16



- cupio cabinets
- cupio mobile
- cupio cupboards
- cupio benches
- cupio accessories
- perfo
- CNC
- verso cabinets
- verso mobile
- verso cupboards
- verso benches
- verso accessories
- facilities
- cases
- seating

cubio | Benches Rear Frame System Kits

1500mm Complete Rear Frame Kits for cubio Benches

- Create an ergonomic workstation
- Models available to suit framework or storage style workbenches
- Rear sections may be 450, 900, 1350 or 1800mm wide and can be configured in any combination up to the width of the bench
- Accessories available in 450, 900, 1350 or 1800mm widths
- Short uprights are suitable for a 2x 240mm or a 480mm high panel and a fixed shelf
- Choose from complete kits or build your own
- Supplied in RAL7035 light grey

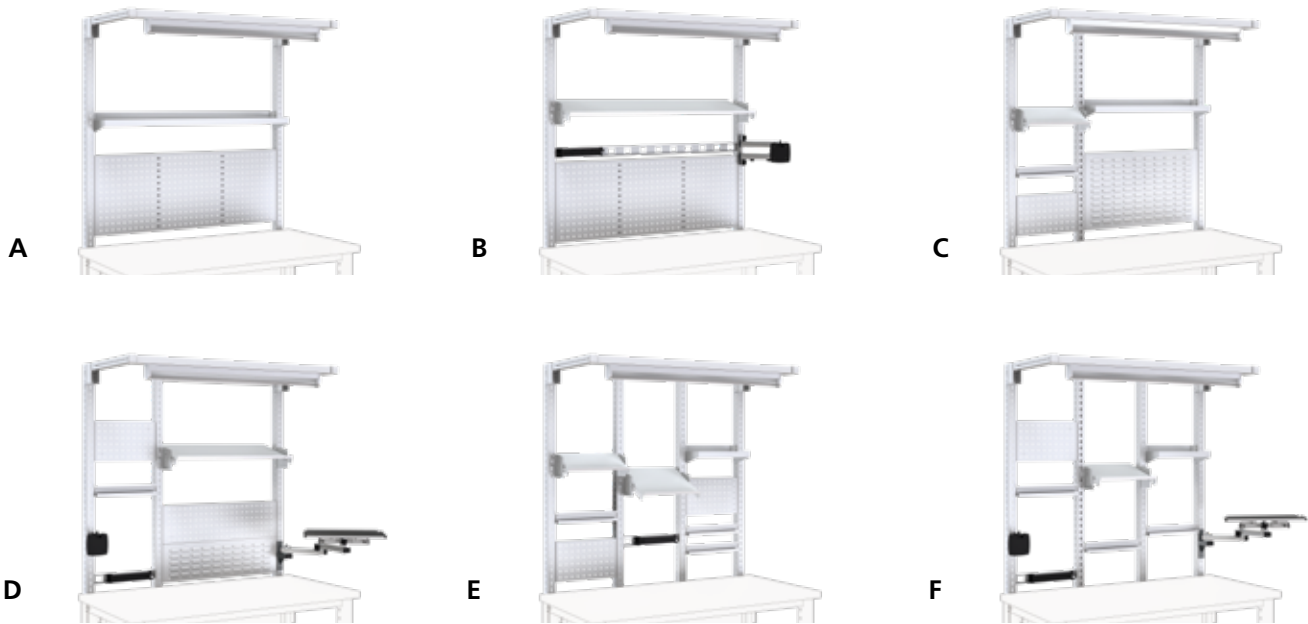

Model	Light	perfo Panel	Louvre Panel	Fixed Shelf	Adjustable Shelf	Power Rail	Power Sockets	Bin Rail	Swivel Tray	Monitor holder	Framework Order Ref.	Storage Order Ref.
A	Yes	1x 1300W x 480H		1x 1300W x 200D							41010183.16	41010258.16
B	Yes	1x 1300W x 480H			1x 1300W x 350D	1x 1300W	4x			1x swivel	41010184.16	41010259.16
	No	1x 900W x 240H	1x 900W x 240H		1x 900W x 350D				1x		41010185.16	41010260.16
C	Yes	1x 450W x 240H	1x 900W x 240H	1x 900W x 200D	1x 450W x 200D			1x 450W			41010186.16	41010261.16
D	Yes	1x 900W x 240H 1x 450W x 240H	1x 900W x 240H		1x 900W x 350D	1x 450W	4x	1x 450W	1x	1x fixed	41010187.16	41010262.16
E	Yes	2x 450W x 240H		1x 450W x 200D	1x 450W x 200D 1x 450W x 350D	1x 450W	4x	3x 450W			41010188.16	41010263.16
F	Yes	1x 450W x 240H		1x 450W x 200D	1x 450W x 350D	1x 450W	4x	3x 450W	1x	1x fixed	41010189.16	41010264.16

2000mm Complete Rear Frame Kits for cubio Benches

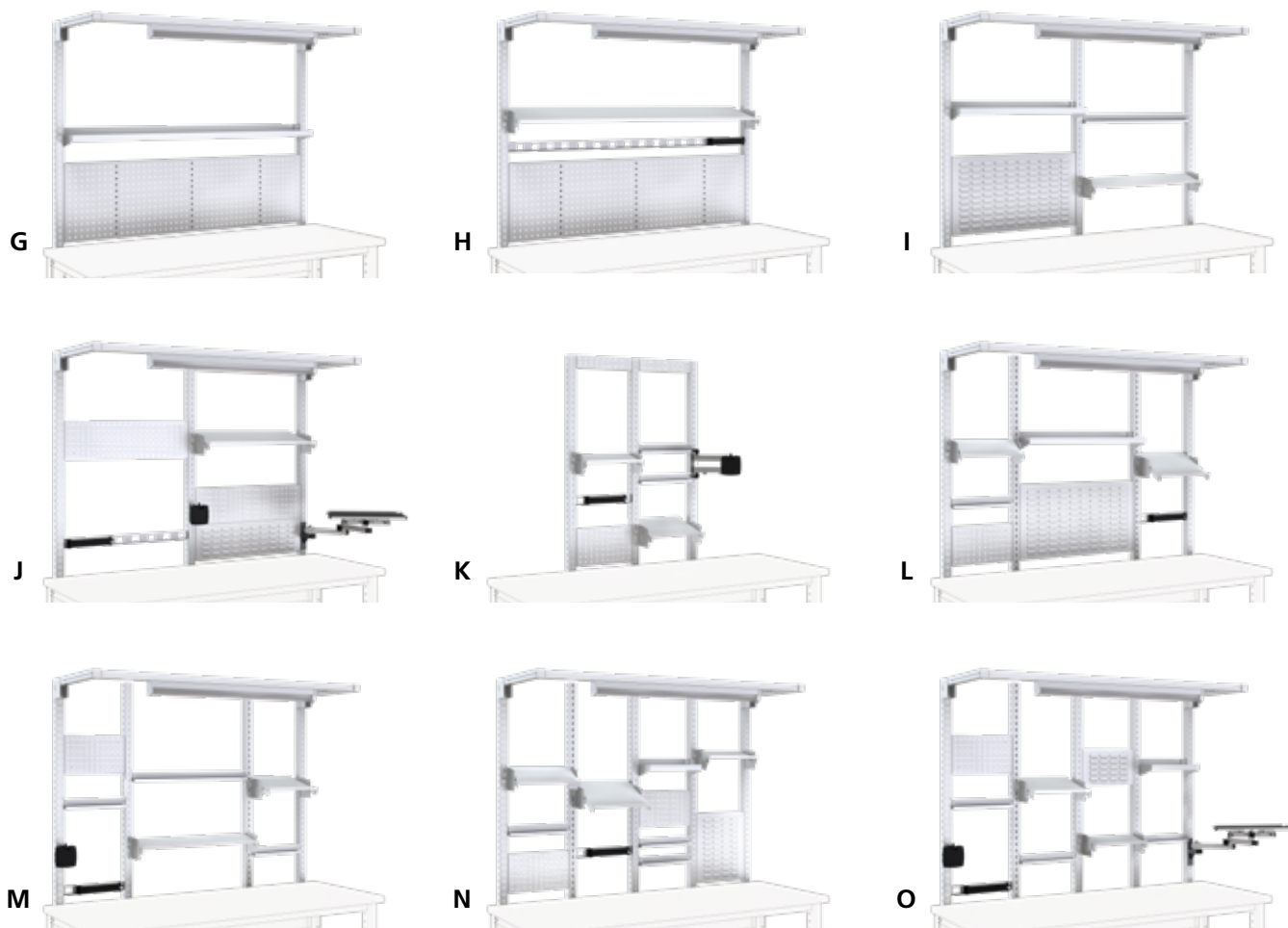

Model	Light	perfo Panel	Louvre Panel	Fixed Shelf	Adjustable Shelf	Power Rail	Power Sockets	Bin Rail	Swivel Tray	Monitor holder	Framework Order Ref.	Storage Order Ref.
G	Yes	1x 1800W x 480H		1x 1800W x 200D							41010193.16	41010265.16
H	Yes	1x 1800W x 480H			1x 1800W x 350D	1x 1800W	6x				41010194.16	41010266.16
I	Yes		1x 900W x 480H	1x 900W x 200D	1x 900W x 200D			1x 900W			41010195.16	41010267.16
J	Yes	2x 900W x 240H	1x 900W x 240H		1x 900W x 350D	1x 900W	4x		1x	1x fixed	41010196.16	41010268.16
K	No	1x 450W x 240H			1x 450W x 200D 1x 450W x 350D	1x 450W	4x	2x 450W		1x swivel	41010197.16	41010269.16
L	Yes	1x 450W x 240H	1x 900W x 480H	1x 900W x 200D	1x 450W x 200D 1x 450W x 350D	1x 450W	4x	1x 450W			41010198.16	41010270.16
M	Yes	1x 450W x 240H			1x 450W x 350D 1x 900W x 200D	1x 450W	4x	2x 450W 1x 900W		1x fixed	41010199.16	41010271.16
N	Yes	2x 450W x 240H	1x 450W x 480H	1x 450W x 200D	2x 450W x 200D 1x 450W x 350D	1x 450W	4x	3x 450W			41010200.16	41010272.16
O	Yes	1x 450W x 240H	1x 450W x 240H	1x 450W x 200D	1x 450W x 200D 1x 450W x 350D	1x 450W	4x	3x 450W	1x	1x fixed	41010201.16	41010273.16

cubio cabinets

cubio mobile

cubio cupboards

cubio benches

cubio accessories

perfo

CNC

verso cabinets

verso mobile

cupboards

benches

accessories

facilities

cases

seating

cubio | Benches Rear Frame System Components

Half Back Frames

- Create an ergonomic workstation
- Suitable for all bench styles
- Fits directly to the worktop
- Rear sections are 900, 1350 or 1800mm wide to suit accessories
- Add accessories to the basic frames
- Supplied in RAL7035 light grey

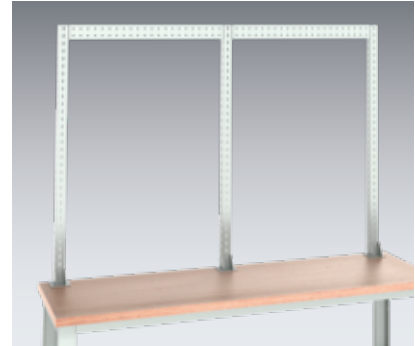

Width (mm)	Accessory width (mm)	Order Ref.
950	1x 900	41010205.16
1400	1x 1350	41010208.16

Width (mm)	Accessory width (mm)	Order Ref.
1850	2x 900	41010212.16
1850	1x 1800	41010213.16

Rear Frame System

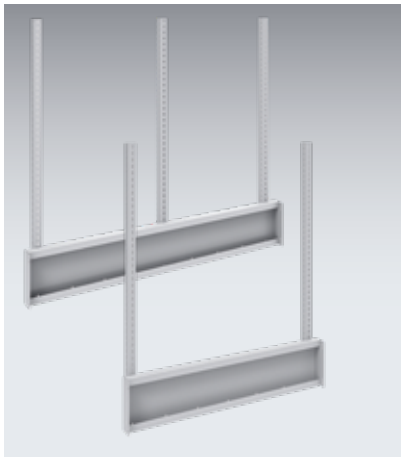

Item	1500 Bench	2000 Bench
	Order Ref.	Order Ref.
Twin upright set for cubio framework bench	41010150.16	41010151.16
Triple upright set for cubio framework bench	41010152.16	41010153.16
Twin upright set for cubio storage bench	41010154.16	41010155.16
Triple upright set for cubio storage bench	41010156.16	41010157.16
Additional upright	41010162.16	41010162.16
Twin short upright set for cubio framework bench	41010234.16	41010235.16
Triple short upright set for cubio framework bench	41010236.16	41010237.16
Twin short upright set for cubio storage bench	41010238.16	41010239.16
Triple short upright set for cubio storage bench	41010240.16	41010241.16
Additional short upright	41010246.16	41010246.16

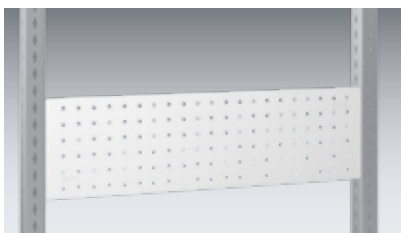

240mm high perfo panel



480mm high louvre panel



Adjustable shelf

Item	450mm Wide	900mm Wide	1350mm Wide	1800mm Wide
	Order Ref.	Order Ref.	Order Ref.	Order Ref.
perfo panel 240mm high	14025340.16	14025341.16	14025342.16	14025343.16
perfo panel 480mm high	14025344.16	14025345.16	14025346.16	14025347.16
Louvre panel 240mm high	14025360.16	14025361.16	14025362.16	14025363.16
Louvre panel 480mm high	14025364.16	14025365.16	14025366.16	14025367.16
Fixed shelf 200mm deep	41010166.16	41010167.16	41010168.16	41010169.16
Adjustable shelf 200mm deep	41010170.16	41010171.16	41010172.16	41010173.16
Adjustable shelf 350mm deep	41010174.16	41010175.16	41010176.16	41010177.16
Bin rail	41011014.16	41011015.16	41011016.16	/

Rear Frame Accessories



LED light and support frame

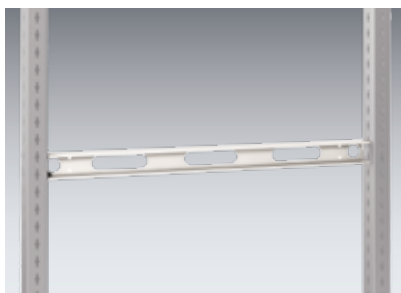

Power rail



Power rail shown with socket outlet strip with FR sockets & switch

Item	450mm Wide	900mm Wide	1350mm Wide	1800mm Wide
	Order Ref.	Order Ref.	Order Ref.	Order Ref.
LED light with support frame	/	41010163.16*	41010164.16	41010165.16
Top brace (for use instead of light)	41011132.16	41011104.16	41011105.16	41011193.16
Power rail	41011250.16	41011251.16	41011252.16	41011253.16
Vertical power rail bracket	41011254.16			
Socket outlet strip with 4 x U.K. sockets & on/off switch	51001128			
Socket outlet strip with 6 x U.K. sockets & on/off switch	51001129			

Choose the correct length / type power rail and then add socket outlet strips to suit your requirements.

The overhead lights are supplied with a 3m cable and U.K plug. Socket outlet strips are supplied with a 1.8m U.K. plug.

Please ensure all necessary regulations are adhered to for your application. * - Note the LED light is wider than the 900mm wide frame.



Monitor bracket



Monitor bracket & arm



Swivel arm & tray

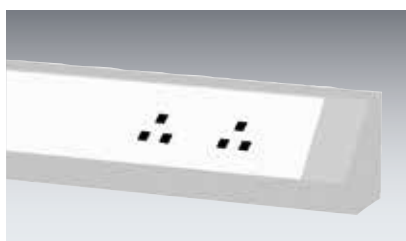

Service duct

Item	Order Ref.
Monitor bracket (VESA 75/100)	41011086
Monitor arm & bracket (VESA 75/100)	41011087
Swivel arm & tray	41011061.20
Service duct with 4 x UK sockets and 3m cable & UK plug (1500mm)	11042235
Service duct with 4 x UK sockets and 3m cable & UK plug (2000mm)	11042236

cubio | Benches Worktops

Beech Multiplex (Mpx)



40mm beech block.

A high load bearing worktop with good surface resistance to water, oils, acids and chemicals. Suitable for most benching applications.



40mm, resin bonded, layered hardwood beech ply with cross laminated construction.

A tough general duty worktop suitable for most applications.

Phenol



40mm top with hardwood core impregnated with phenol resin and edged in hardwood.

Lino

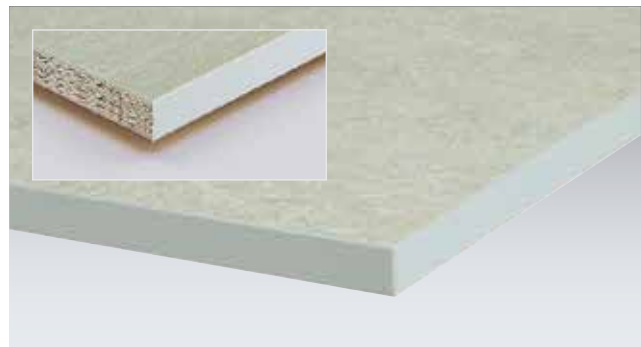

40mm overall with a 38mm particle board core and a 2mm grey linoleum surface and a durable plastic edgebanding.

An easy clean top with good surface resistance to water, oils, acids and chemicals.

Size (mm)	Beech	Multiplex	Phenol	Lino
	Order Ref.	Order Ref.	Order Ref.	Order Ref.
750 x 750	41201031.07V	41201031.08V	41201031.10V	41201031.15V
1500 x 750	41201033.07V	41201033.08V	41201033.10V	41201033.15V
2000 x 750	41201036.07V	41201036.08V	41201036.10V	41201036.15V
1500 x 900	41201065.07V	41201065.08V	41201065.10V	41201065.15V
2000 x 900	41201066.07V	41201066.08V	41201066.10V	41201066.15V

Laminate



40mm particle board core with grey laminate surface and ABS antistatic edges.

An easy clean top with high abrasion and impact resistance and excellent surface resistance to boiling water, oils, weak acids and chemicals.

Laminate / ESD Laminate



40mm particle board core with grey laminate surface and ABS antistatic edges.

An easy clean top with high abrasion and impact resistance and excellent surface resistance to boiling water, oils, weak acids and chemicals.

This ESD versio has conductive core and surface with leakage values in accordance with IEC 61340.

Steel Clad

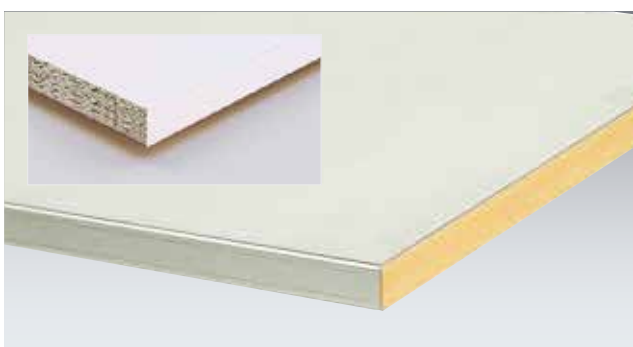

38mm particle board core with 1.2 mm galvanised steel cladding to surface, front and rear edges.

An extremely hard wearing, heavy duty surface for heavy engineering or hot components.

Stainless Clad



38mm particle board core with 1.2 mm stainless steel for the surface and all edges.

Size (mm)	Laminate	ESD Laminate	Steel Clad	Stainless Steel Clad
	Order Ref.	Order Ref.	Order Ref.	Order Ref.
750 x 750	41201031.02V	41201031.05V	41201031.14V	41201031.28V
1500 x 750	41201033.02V	41201033.05V	41201033.14V	41201033.28V
2000 x 750	41201036.02V	41201036.05V	41201036.14V	41201036.28V
1500 x 900	41201065.02V	41201065.05V	41201065.14V	41201065.28V
2000 x 900	41201066.02V	41201066.05V	41201066.14V	41201066.28V

cubio | Benches Worktops

Custom Worktops

Corner 'T' shape and hexagon worktops for use in custom installations.

The 750mm sections integrate with the standard worktops and the corner sections allow 1050mm wide or 525mm square cabinets to sit underneath.

The hexagon worktop allows up to 6 650 wide x 650 deep cabinets

As well as cabinets, the worktops can be supported by the cubio endframes and support brackets.

See pages 105 - 106 for pre built versions.



Custom Worktops

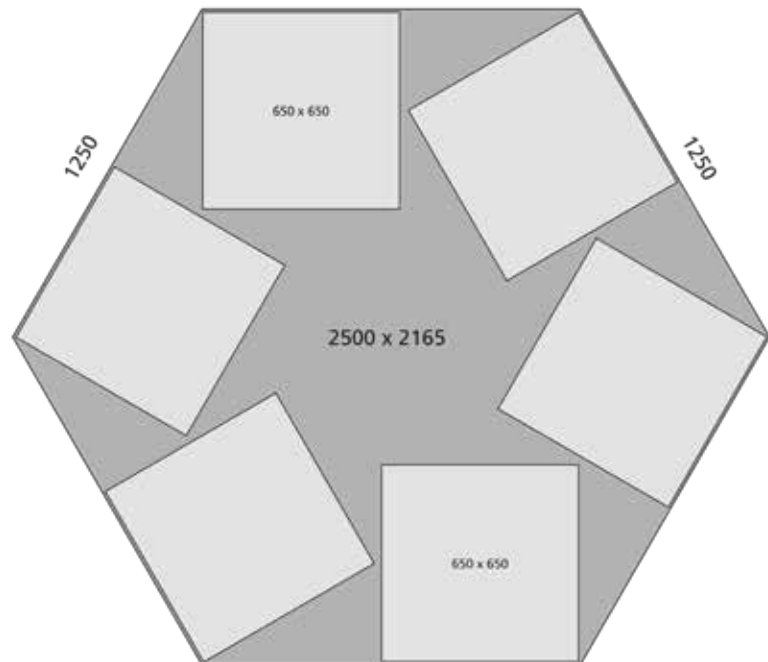
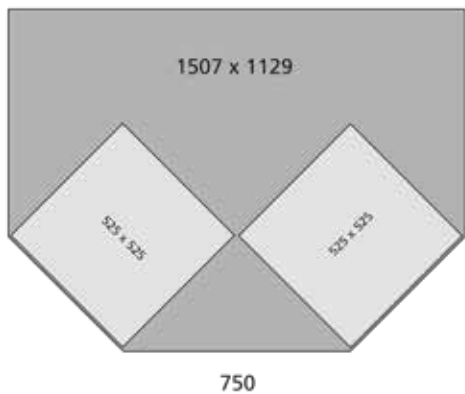

Type	Overall Size (mm)	Mpx top	Lino top
		Order Ref.	Order Ref.
'T'	1507 x 1129 x 40	41201068.08V	41201068.15V

Type	Overall Size (mm)	Mpx top	Lino top
		Order Ref.	Order Ref.
Hexagon	2500 x 2165 x 40	41201041.08V	41201041.15V

Custom Worktops

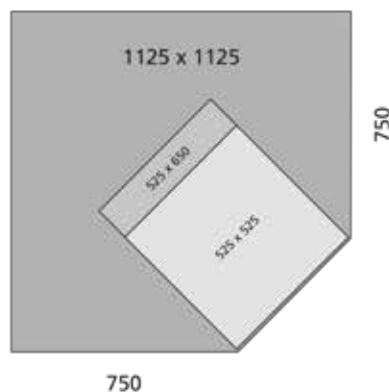
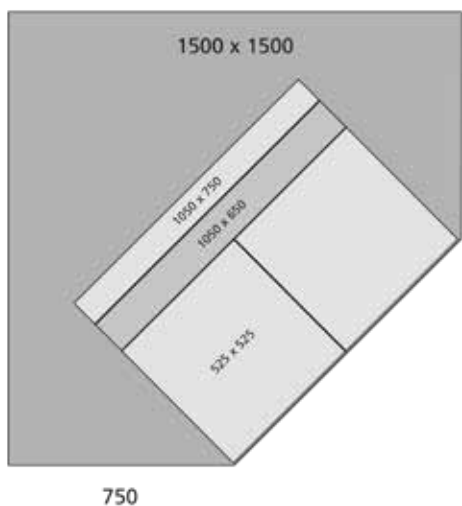

Type	Overall Size (mm)	Mpx top	Lino top
		Order Ref.	Order Ref.
Corner	1500 x 1500 x 40	41201067.08V	41201067.15V

Type	Overall Size (mm)	Mpx top	Lino top
		Order Ref.	Order Ref.
Corner	1125 x 1125 x 40	41201170.08V	41201170.15V



- cupboards
- mobile
- cupboards
- benches
- accessories
- perfo
- CNC
- cupboards
- mobile
- cupboards
- benches
- accessories
- facilities
- cases
- seating

cubio | Benches Bench Components

Endframes and Cross Brace Stringer Sets

Robust steel endframes in fixed, adjustable height and mobile versions. Use on their own for pedestal applications or with the horizontal stringer sets to create a full framework.

The full stringer sets are available for use with 1500 and 2000mm long tops and consist of two top and one base cross member.

Top stringer sets must be used in conjunction with a base shelf.



Item	Depth x Height (mm)	Order Ref.
Static endframe	650 x 800	41401001.16V
Static endframe	650 x 900	41401002.16V
Static endframe	800 x 800	41401017.16V
Adjustable endframe	650 x 700 - 1100	41401005.16V
Adjustable endframe	800 x 700 - 1100	41401006.16V
Mobile endframe	650 x 800 - 1100	41401009.16V
Mobile endframe	800 x 800 - 1100	41401010.16V
Full stringer set	For 1500mm long benches	41010020.16V
Full stringer set	For 2000mm long benches	41010022.16V
Top stringer set	For 1500mm long benches with base shelf	41010021.16V
Top stringer set	For 2000mm long benches with base shelf	41010023.16V



Worktop Support Brackets

Steel joining plates and wall supports for use with extended worktop runs and custom installation. RAL7035 grey finish.

Type	Size (mm)	Order Ref.
Wall support	500 x 75	11204025.16
Wall support	750 x 75	11204026.16
Joining plate	250 x 100	11204021.16
Joining plate	250 x 200	11204022.16
Joining plate	500 x 100	11204023.16
Joining plate	500 x 200	11204024.16

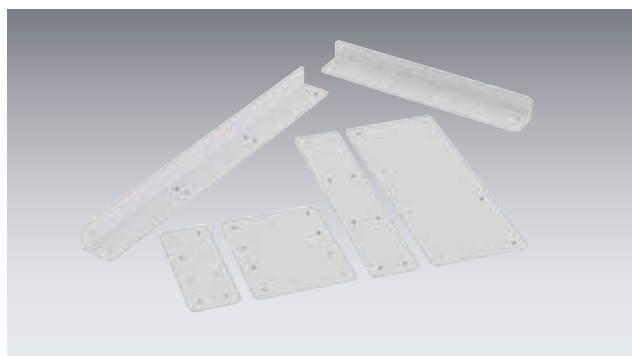

verso - Benches





Robust Construction

With robust construction and up to 600kg U.D.L total capacity, verso benches are strong, reliable and built to last. Choose from framework, cantilever, pedestal, storage or welded styles.

Worktop Options

30mm worktops are used on framework, storage and pedestal benches and 20mm on welded and cantilever styles. Choose from Multiplex, Lino or ESD Laminate. MFC Laminate is also available for cantilever benches.

Ergonomic Working

Many verso bench styles offer fixed or height adjustable options and mobile alternatives are available for framework, workstand and welded styles. Rear and overhead frame kits can be used to create efficient and ergonomic workstations; including, swivel arms, storage panels, adjustable shelves, service ducts and lighting.

Wide Range of Accessories

Create custom configurations by combining verso bench systems with our wide range of accessories including; backpanels, drawer dividers and hook and bin kits.

To ensure maximum stability all static verso benches should be bolted to the floor.

Multiplex (Mpx)



30mm, resin bonded, layered hardwood beech ply with cross laminated construction.

A tough general duty worktop suitable for most applications.

Lino

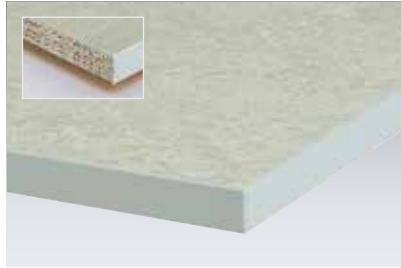

30mm overall with a 28mm particle board core and a 2mm grey linoleum surface and a durable plastic edgbanding.

An easy clean top with good surface resistance to water, oils, acids and chemicals. Ideal for office, assembly and storage areas.

MFC Laminate

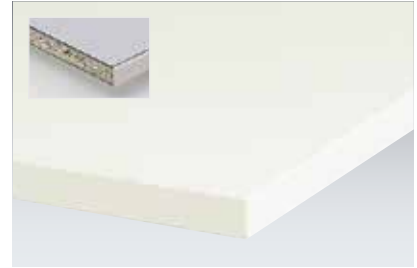

20mm with particle board core, with MFC laminate surface and plastic edgbanding.

An easy clean top with high abrasion resistance and excellent surface resistance to water, oils and weak chemicals. For cantilever benches only.

ESD Laminate

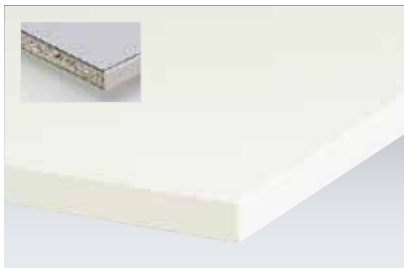

30mm conductive particle board core with conductive laminate surface and ABS antistatic edges.

An easy clean top with high abrasion resistance and excellent surface resistance to water, oils, weak chemicals.



verso | Benches Welded Benches

cubio cabinets
 cubio mobile
 cubio cupboards
 cubio benches
 cubio accessories
 perfo
 CNC
 verso cabinets
 verso mobile
 verso cupboards
 verso benches
 verso accessories
 facilities
 cases
 seating

Welded Benches

- Heavy duty steel framework with rear upstand
- Full depth steel base shelf
- Mobile models have 125mm diameter castors
- Steel top models 910mm high
- Mpx top models 930mm high
- All models 600mm deep
- Benches supplied assembled, drawers or cupboards will require fitting to the bench.



Basic Bench

Length	Type	Worktop	
		Steel Order Ref.	Multiplex Order Ref.
1000	Static	16922502.16	16922503.16
1000	Mobile	16922700.16	16922701.16
1500	Static	16922506.16	16922507.16



Bench with Cupboard



Model shown static 1500mm with mpx top.
Cupboard: 600mm high x 525mm wide x 550mm deep with 1x adjustable shelf (75kg U.D.L. capacity)

Length	Type	Worktop	
		Steel Order Ref.	Multiplex Order Ref.
1000	Static	16922602.19	16922603.19
1000	Mobile	16922802.19	16922803.19
1500	Static	16922606.19	16922607.19

Bench with Drawer



Model shown static 1500mm with steel top.
Drawer: 250mm high x 525mm wide x 550mm deep (75kg U.D.L. capacity)

Length	Type	Worktop	
		Steel Order Ref.	Multiplex Order Ref.
1000	Static	16922600.19	16922601.19
1000	Mobile	16922800.19	16922801.19
1500	Static	16922604.19	16922605.19

Housing:

RAL 7035 – light grey

Fronts:

RAL 7016 – anthracite grey

RAL 5010 – gentian blue

RAL 7035 – light grey

RAL 3004 – crimson red

verso | Benches Framework Benches

Framework Benches

- Robust steel section framework
- 30mm worktops
- Mobile model has 125mm diameter castors
- Optional storage units available - see page 277
- Static models are compatible with the rear frame system
- Comprehensive self assembly instructions included

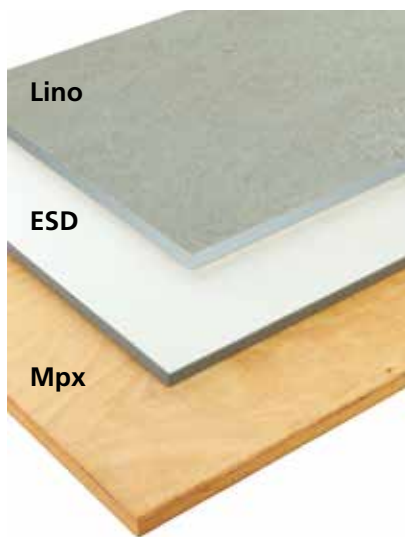

Basic Workstands 700mm Wide x 600mm Deep

Length	Depth	Height	Type	Worktop	
				Multiplex	Lino
				Order Ref.	Order Ref.
700	600	780 - 930	Static	16921500.16	16921501.16
700	600	930	Mobile	16922100.16	16922101.16



Basic Bench, 780 - 930mm Adjustable height



Length	Depth	Worktop		
		Multiplex	Lino	ESD Laminate
		Order Ref.	Order Ref.	Order Ref.
1500	600	16921504.16	16921505.16	16921520.16
1500	800	16921512.16	16921513.16	16921522.16
2000	600	16921506.16	16921507.16	16921521.16
2000	800	16921514.16	16921515.16	16921523.16

Bench with Full Depth Shelf, 780 - 930mm Adjustable height



Length	Depth	Worktop		
		Multiplex	Lino	ESD Laminate
		Order Ref.	Order Ref.	Order Ref.
1500	600	16922002.16	16922003.16	16922009.16
1500	800	16922022.16	16922023.16	16922029.16
2000	600	16922006.16	16922007.16	16922011.16
2000	800	16922026.16	16922027.16	16922031.16

Mobile Bench, 930mm High



Length	Depth	Worktop	
		Multiplex	Lino
		Order Ref.	Order Ref.
1000	600	16922102.16	16922103.16
1000	800	16922110.16	16922111.16
1500	600	16922104.16	16922105.16
1500	800	16922112.16	16922113.16

The base shelf may be used as a tray as shown or inverted to give a flat shelf.

Housing:

RAL 7035 – light grey

Fronts:

RAL 7016 – anthracite grey

RAL 5010 – gentian blue

RAL 7035 – light grey

RAL 3004 – crimson red

verso | Benches Framework Benches with Suspended Cabinets

Storage Workstands 700mm Wide x 600mm Deep



Model	Type	Cabinet W x D x H	Drawers	Mpx worktop	Lino worktop
				Order Ref.	Order Ref.
A	Static	525 x 550 x 250	1x 175	16921600.19	16921601.19
	Mobile	525 x 550 x 250	1x 175	16922200.19	16922201.19
B	Static	525 x 550 x 450	3x 125	16921602.19	16921603.19
	Static	525 x 550 x 600	525mm cupboard with shelf	16921614.19	16921615.19
C	Mobile	525 x 550 x 600	525mm cupboard with shelf	16922202.19	16922203.19

Framework Bench with Cabinet



Width x Depth x Height (mm)	Cabinet W x D x H	Drawers	Mpx worktop	Lino worktop
			Order Ref.	Order Ref.
1500 x 600 x 780 - 930	525 x 550 x 250	1x 175	16921650.19	16921651.19
1500 x 800 x 780 - 930	525 x 550 x 250	1x 175	16921670.19	16921671.19
2000 x 600 x 780 - 930	525 x 550 x 250	1x 175	16921700.19	16921701.19
2000 x 800 x 780 - 930	525 x 550 x 250	1x 175	16921720.19	16921721.19

Framework Bench with Cabinet

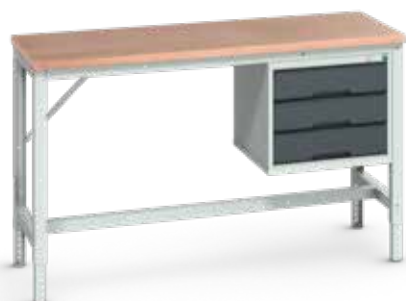

Width x Depth x Height (mm)	Cabinet W x D x H	Drawers	Mpx worktop	Lino worktop
			Order Ref.	Order Ref.
1500 x 600 x 780 - 930	525 x 550 x 450	3x 125	16921652.19	16921653.19
1500 x 800 x 780 - 930	525 x 550 x 450	3x 125	16921672.19	16921673.19
2000 x 600 x 780 - 930	525 x 550 x 450	3x 125	16921702.19	16921703.19
2000 x 800 x 780 - 930	525 x 550 x 450	3x 125	16921722.19	16921723.19

Framework Bench with Cupboard



Width x Depth x Height (mm)	Cabinet W x D x H	Cupboard	Mpx worktop	Lino worktop
			Order Ref.	Order Ref.
1500 x 600 x 780 - 930	525 x 550 x 600	525mm cupboard with shelf	16921664.19	16921665.19
1500 x 800 x 780 - 930	525 x 550 x 600	525mm cupboard with shelf	16921684.19	16921685.19
2000 x 600 x 780 - 930	525 x 550 x 600	525mm cupboard with shelf	16921714.19	16921715.19
2000 x 800 x 780 - 930	525 x 550 x 600	525mm cupboard with shelf	16921734.19	16921735.19

Housing:

RAL 7035 – light grey
.19
.11
RAL 7035 – light grey
.24

Fronts:

RAL 7016 – anthracite grey
RAL 5010 – gentian blue
RAL 7035 – light grey
RAL 3004 – crimson red

cupio
cabinets

cupio
mobile

cupio
cupboards

cupio
benches

cupio
accessories

perfo

CNC

verso
cabinets

verso
mobile

verso
cupboards

verso
benches

verso
accessories

facilities

cases

seating

verso | Benches Cantilever Benches

Cantilever Benches

- For assembly and office areas
- 20mm worktops
- Robust steel framework with clear front access
- Add on cabinets as required
- Comprehensive self assembly instructions included

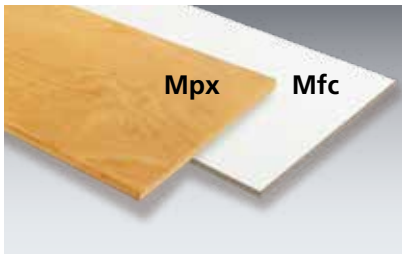

780mm High Benches

930mm High Benches



Length	Depth	Worktop	Order Ref.
1500	600	Mpx	16922304.16
1500	800	Mpx	16922324.16
2000	600	Mpx	16922308.16
2000	800	Mpx	16922328.16
1500	600	Mfc	16922305.16
1500	800	Mfc	16922325.16
2000	600	Mfc	16922309.16
2000	800	Mfc	16922329.16

Length	Depth	Worktop	Order Ref.
1500	600	Mpx	16922306.16
1500	800	Mpx	16922326.16
2000	600	Mpx	16922310.16
2000	800	Mpx	16922330.16
1500	600	Mfc	16922307.16
1500	800	Mfc	16922327.16
2000	600	Mfc	16922311.16
2000	800	Mfc	16922331.16

verso | Benches Suspended Cabinets

Suspended Cabinets

Under Bench Storage Units suitable for framework and cantilever benches mounting directly to the frame.

- Central locking drawers, lockable cupboards
- Roller bearing drawers with 75kg U.D.L. capacity and 100% extension slides
- Optional divider kits available - see page 290

1500 benches can use 2x 525w or 1x 800w cabinets,
2000 benches accept 3x 525w or 2x 800w cabinets.

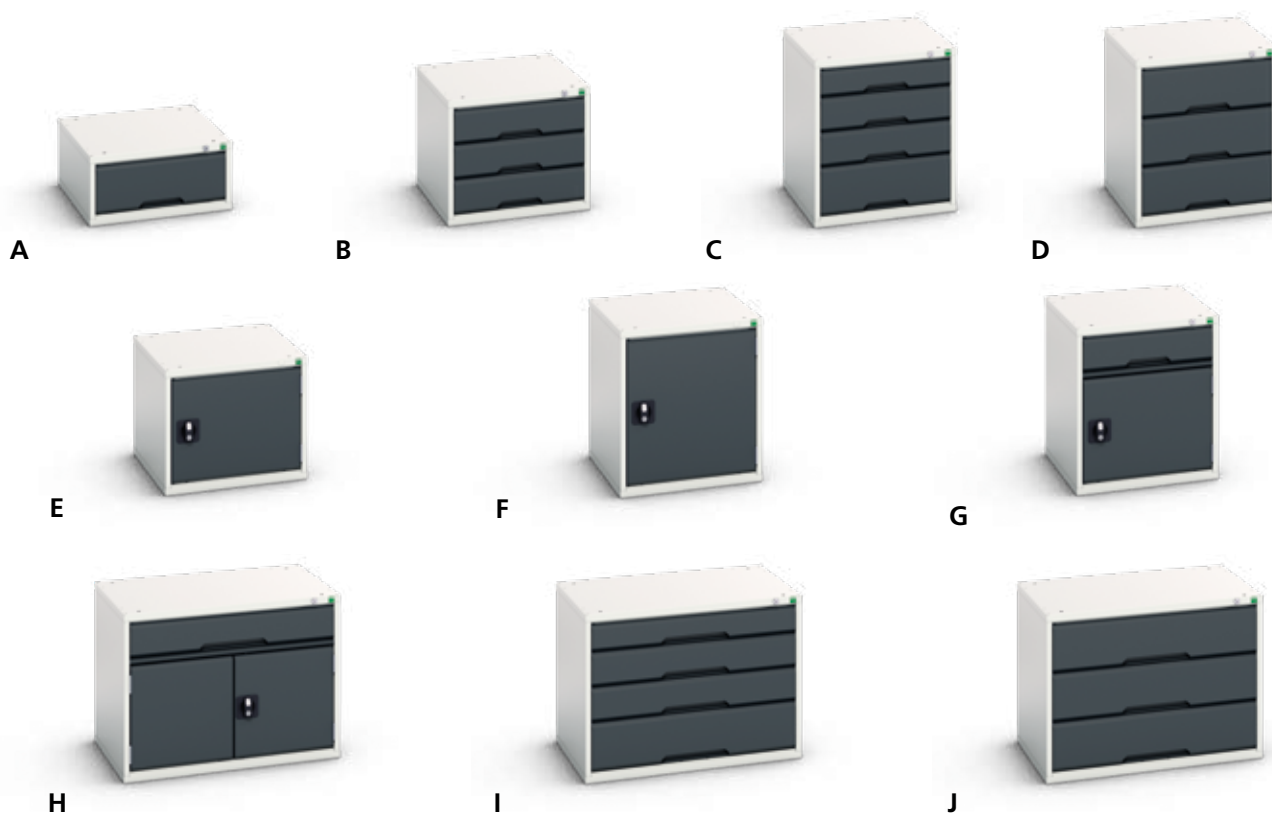

Model	Width	Depth	Height	Configuration	Order Ref.
A	525	550	250	1x 175mm drawer	16925000.19
B	525	550	450	3x 125mm drawers	16925001.19
C	525	550	600	1x 100mm, 2x 125mm, 1x 175mm drawers	16925004.19
D	525	550	600	3x 175mm drawers	16925003.19
E	525	550	450	375mm door, 1x shelf	16926030.19
F	525	550	600	525mm door, 1x shelf	16926032.19
G	525	550	600	1x 125mm drawer, 375mm door, 1x shelf	16925006.19
H	800	550	600	1x 125mm drawer, 375mm door, 1x shelf	16925106.19
I	800	550	600	1x 100mm, 2x 125mm, 1x 175mm drawers	16925104.19
J	800	550	600	3x 175mm drawers	16925103.19

Housing:

RAL 7035 – light grey

Fronts:

.19 RAL 7016 – anthracite grey

.11 RAL 5010 – gentian blue

.16 RAL 7035 – light grey

.24 RAL 3004 – crimson red

verso
cubio
cabinets

verso
cubio
mobile

verso
cubio
cupboards

verso
cubio
benches

verso
cubio
accessories

verso
perfo

verso
CNC

verso
cabinets

verso
mobile

verso
cupboards

verso
benches

verso
accessories

verso
facilities

verso
cases

verso
seating

verso | Benches Pedestal Benches

Pedestal Benches

- Up to 300kg U.D.L. capacity
- Central locking drawers and lockable cupboards
- Roller bearing drawers with 75kg U.D.L. capacity and 100% extension slides
- Compatible with optional divider kits - see page 290
- 30mm thick worktops
- For more cabinet information see page 228 - 241
- All models 600mm deep x 930mm high

Cabinets are 900mm high x 550mm deep x 525 / 800mm wide

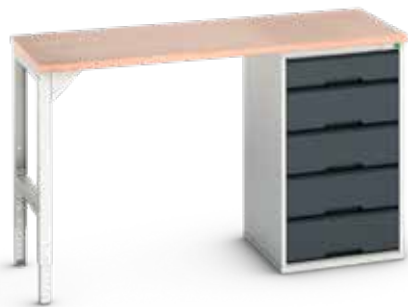

A



Model	Width x Depth x Height (mm)	Cabinet W x D x H	Drawers	Mpx worktop	Lino worktop
				Order Ref.	Order Ref.
A	1500 x 600 x 930	525 x 550 x 900	1x 125, 4x 175	16921900.19	16921910.19
	2000 x 600 x 930	525 x 550 x 900	1x 125, 4x 175	16921950.19	16921960.19



B

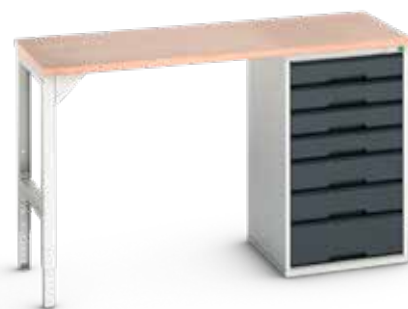

C

Model	Width x Depth x Height (mm)	Cabinet W x D x H	Drawers	Mpx worktop	Lino worktop
				Order Ref.	Order Ref.
B	1500 x 600 x 930	525 x 550 x 900	1x 125, 1x 175 / 500 cupboard with shelf	16921902.19	16921912.19
	2000 x 600 x 930	525 x 550 x 900	1x 125, 1x 175 / 500 cupboard with shelf	16921952.19	16921962.19
C	1500 x 600 x 930	525 x 550 x 900	4x 100, 2x 125, 1x 175	16921901.19	16921911.19
	2000 x 600 x 930	525 x 550 x 900	4x 100, 2x 125, 1x 175	16921951.19	16921961.19

Pedestal Benches



D

Model	Width x Depth x Height (mm)	Cabinet W x D x H	Drawers	Mpx worktop	Lino worktop
				Order Ref.	Order Ref.
	1500 x 600 x 930	800 x 550 x 900	1x 125, 1x 175 / 500 cupboard with shelf	16921905.19	16921915.19
D	2000 x 600 x 930	800 x 550 x 900	1x 125, 1x 175 / 500 cupboard with shelf	16921955.19	16921965.19



E

E

Model	Width x Depth x Height (mm)	Cabinet W x D x H	Drawers	Mpx worktop	Lino worktop
				Order Ref.	Order Ref.
E	1500 x 600 x 930	800 x 550 x 900	4x 100, 2x 125, 1x 175	16921904.19	16921914.19
	2000 x 600 x 930	800 x 550 x 900	4x 100, 2x 125, 1x 175	16921954.19	16921964.19

Housing:

RAL 7035 – light grey

Fronts:

RAL 7016 – anthracite grey .19

RAL 5010 – gentian blue .11

RAL 7035 – light grey .16

RAL 3004 – crimson red .24

cubio
cabinets

cubio
mobile

cubio
cupboards

cubio
benches

cubio
accessories

perfo

CNC

verso
cabinets

verso
mobile

verso
cupboards

verso
benches

verso
accessories

facilities

cases

seating

verso | Benches Storage Benches

Storage Benches

- 30mm multiplex worktops
- Steel frame with integrated storage modules
- Access beneath bench allows good housekeeping
- Individual lockable cupboards and cabinets
- Roller bearing drawers with 75kg U.D.L. capacity and 100% extension slides
- Open areas supplied with adjustable shelf
- Storage units are 443mm or 718mm wide, 550mm deep x 600mm high
- Static models are height adjustable from 830mm - 930mm
- Mobile models are 830mm high with 125mm diameter castors
- 600mm Deep
- Supplied assembled ready to use
- 1500 and 2000mm static models are compatible with the rear frame system



See pages 290 - 292

443mm wide units use the 525mm wide cabinet dividers. 718mm wide units use the 800mm wide cabinet dividers

1250mm Wide



1x 443w cabinet with 1x 125 drawers, 1x 350h cupboard, 1x 443w shelf

Type	Size	Order Ref.
Static	1250 x 600	16923000.19
Mobile	1250 x 600	16923200.19



2x 443w cabinets with 2x 125 drawers, 2x 350h cupboards

Type	Size	Order Ref.
Static	1250 x 600	16923001.19
Mobile	1250 x 600	16923201.19

1250mm Wide



1x 443w cabinet with 1x 125, 2x 175h drawers, 1x 443w x 475h cupboard

Type	Size	Order Ref.
Static	1250 x 600	16923003.19
Mobile	1250 x 600	16923203.19



2x 443w cabinets with 2x 125, 4x 175h drawers

Type	Size	Order Ref.
Static	1250 x 600	16923004.19
Mobile	1250 x 600	16923204.19

1500mm Wide



1x 443w cabinet with 1x 125 2x 175h drawers, 1x 718w shelf

Type	Size	Order Ref.
Static	1500 x 600	16923012.19
Mobile	1500 x 600	16923212.19



1x 718w cabinet with 1x 125, 2x 175h drawers, 1x 443w shelf

Type	Size	Order Ref.
Static	1500 x 600	16923013.19
Mobile	1500 x 600	16923213.19



1x 443w x 475h cupboard, 1x 718w cabinet with 1x 125, 2x 175h drawers

Type	Size	Order Ref.
Static	1500 x 600	16923014.19
Mobile	1500 x 600	16923214.19



1x 443w, 1x 718w cabinets with 2x 125, 4x 175h drawers

Type	Size	Order Ref.
Static	1500 x 600	16923015.19
Mobile	1500 x 600	16923215.19

Housing:

RAL 7035 – light grey	RAL 7016 – anthracite grey	RAL 5010 – gentian blue	RAL 7035 – light grey	RAL 3004 – crimson red

Fronts:

RAL 7035 – light grey	RAL 7016 – anthracite grey	RAL 5010 – gentian blue	RAL 7035 – light grey	RAL 3004 – crimson red

cupio
cabinets

cupio
mobile

cupio
cupboards

cupio
benches

cupio
accessories

perfo

CNC

verso
cabinets

verso
mobile

verso
cupboards

verso
benches

verso
accessories

facilities

cases

seating

verso | Benches Storage Benches

1750mm Wide



2x 443w cabinets with 1x 125, 2x 175 drawers and 475h cupboard, 1x 443w shelf

Type	Size	Order Ref.
Static	1750 x 600	16923020.19
Mobile	1750 x 600	16923220.19



2x 443w cabinets with 2x 125h drawers and 2x 350h cupboards, 1x 443w shelf

Type	Size	Order Ref.
Static	1750 x 600	16923021.19
Mobile	1750 x 600	16923221.19



2x 475h x 443w cupboards, 1x 443w cabinet with 1x 125, 2x 175h drawers

Type	Size	Order Ref.
Static	1750 x 600	16923022.19
Mobile	1750 x 600	16923222.19

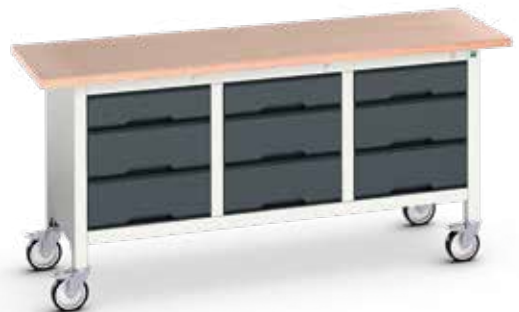

3x 475h x 443w cabinets with 3x 125, 6x 175h drawers

Type	Size	Order Ref.
Static	1750 x 600	16923023.19
Mobile	1750 x 600	16923223.19

Dividers



See pages 290 - 292

443mm wide units use the 525mm wide cabinet dividers. 718mm wide units use the 800mm wide cabinet dividers

2000mm Wide



2x 475h x 443w cupboards, 1x 718w cabinet with 1x 125, 2x 175h drawers

Type	Size	Order Ref.
Static	2000 x 600	16923032.19
Mobile	2000 x 600	16923232.19



2x 443w cabinets with 2x 125 drawers, 2x 350h cupboards, 1x 718w shelf

Type	Size	Order Ref.
Static	2000 x 600	16923031.19
Mobile	2000 x 600	16923231.19

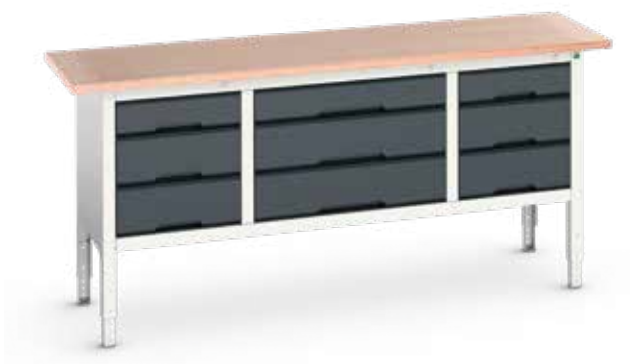

2x 443w cabinets, 1x 718w cabinet with 3x 125, 6x 175h drawers

Type	Size	Order Ref.
Static	2000 x 600	16923033.19
Mobile	2000 x 600	16923233.19



2x 443w cabinets with 2x 125, 4x 175h drawers, 1x 718w shelf

Type	Size	Order Ref.
Static	2000 x 600	16923034.19
Mobile	2000 x 600	16923234.19

Mid / Cupboard Shelf



Cupboard Width (mm)	Order Ref.
443	16926912.51
718	16926915.51

Housing:

RAL 7035 – light grey

Fronts:

RAL 7016 – anthracite grey

RAL 5010 – gentian blue

RAL 7035 – light grey

RAL 3004 – crimson red

cubio
cabinets

cubio
mobile

cubio
cupboards

cubio
benches

cubio
accessories

perfo

CNC

verso
cabinets

verso
mobile

verso
cupboards

verso
benches

verso
accessories

facilities

cases

seating

verso | Benches Rear Frame System Kits

1500mm Complete Rear Frame Kits for verso Benches

- Create an ergonomic workstation
- Models available to suit framework or storage style workbenches
- Rear sections may be 450, 900, 1350 or 1800mm wide and can be configured in any combination up to the width of the bench
- Accessories available in 450, 900, 1350 or 1800mm widths
- Short uprights are suitable for a 2x 240mm or a 480mm high panel and a fixed shelf
- Choose from complete kits or build your own
- Supplied in RAL7035 light grey



Model	Light	perfo Panel	Louvre Panel	Fixed Shelf	Adjustable Shelf	Power Rail	Power Sockets	Bin Rail	Swivel Tray	Monitor holder	Framework Order Ref.	Storage Order Ref.
A	Yes	1x 1300W x 480H		1x 1300W x 200D							16924402.16	16924422.16
B	Yes	1x 1300W x 480H			1x 1300W x 350D	1x 1300W	4x			1x swivel	16924403.16	16924423.16
	No	1x 900W x 240H	1x 900W x 240H		1x 900W x 350D				1x		16924404.16	16924424.16
C	Yes	1x 450W x 240H	1x 900W x 240H	1x 900W x 200D	1x 450W x 200D			1x 450W			16924405.16	16924425.16
D	Yes	1x 900W x 240H 1x 450W x 240H	1x 900W x 240H		1x 900W x 350D	1x 450W	4x	1x 450W	1x	1x fixed	16924406.16	16924426.16
E	Yes	2x 450W x 240H		1x 450W x 200D	1x 450W x 200D 1x 450W x 350D	1x 450W	4x	3x 450W			16924407.16	16924427.16
F	Yes	1x 450W x 240H		1x 450W x 200D	1x 450W x 350D	1x 450W	4x	3x 450W	1x	1x fixed	16924408.16	16924428.16

2000mm Complete Rear Frame Kits for verso Benches

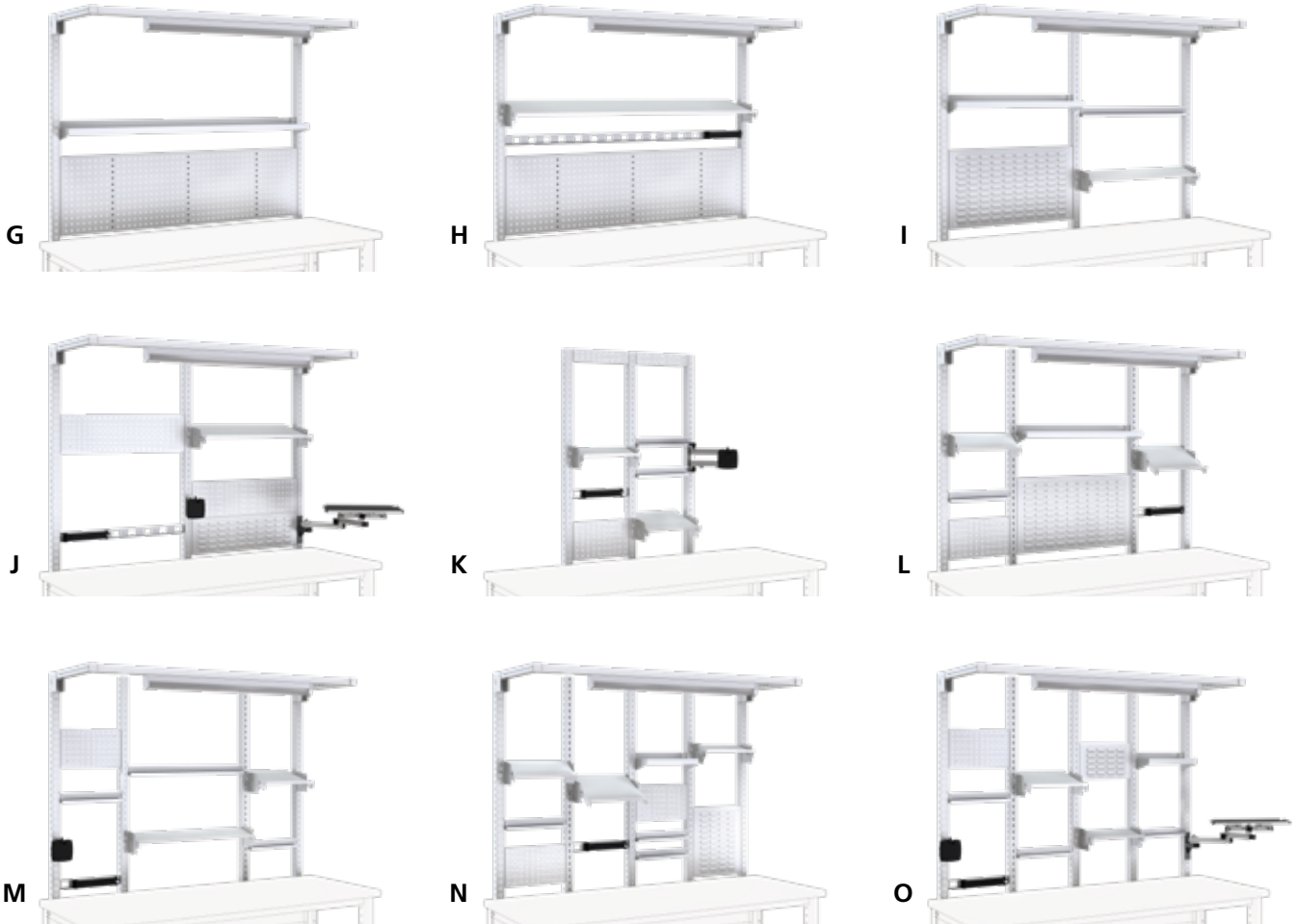

Model	Light	perfo Panel	Louvre Panel	Fixed Shelf	Adjustable Shelf	Power Rail	Power Sockets	Bin Rail	Swivel Tray	Monitor holder	Framework Order Ref.	Storage Order Ref.
G	Yes	1x 1800W x 480H		1x 1800W x 200D							16924602.16	16924622.16
H	Yes	1x 1800W x 480H			1x 1800W x 350D	1x 1800W	6x				16924603.16	16924623.16
I	Yes		1x 900W x 480H	1x 900W x 200D	1x 900W x 200D			1x 900W			16924604.16	16924624.16
J	Yes	2x 900W x 240H	1x 900W x 240H		1x 900W x 350D	1x 900W	4x		1x	1x fixed	16924605.16	16924625.16
K	No	1x 450W x 240H			1x 450W x 200D 1x 450W x 350D	1x 450W	4x	2x 450W		1x swivel	16924606.16	16924626.16
L	Yes	1x 450W x 240H	1x 900W x 480H	1x 900W x 200D	1x 450W x 200D 1x 450W x 350D	1x 450W	4x	1x 450W			16924607.16	16924627.16
M	Yes	1x 450W x 240H			1x 450W x 350D 1x 900W x 200D	1x 450W	4x	2x 450W 1x 900W		1x fixed	16924608.16	16924628.16
N	Yes	2x 450W x 240H	1x 450W x 480H	1x 450W x 200D	2x 450W x 200D 1x 450W x 350D	1x 450W	4x	3x 450W			16924609.16	16924629.16
O	Yes	1x 450W x 240H	1x 450W x 240H	1x 450W x 200D	1x 450W x 200D 1x 450W x 350D	1x 450W	4x	3x 450W	1x	1x fixed	16924610.16	16924630.16

verso | Benches Rear Frame System Components

Half back frames

- Create an ergonomic workstation
- Suitable for all bench styles
- Fits directly to the worktop
- Rear sections are 900, 1350 or 1800mm wide to suit accessories
- Add accessories to the basic frames
- Supplied in RAL7035 light grey

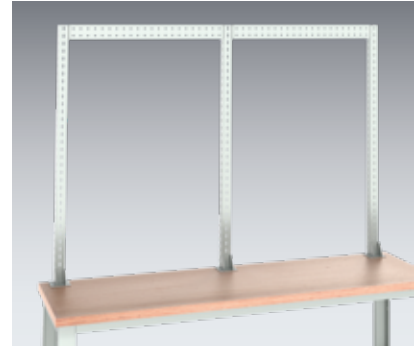

Width (mm)	Accessory width (mm)	Order Ref.
950	1x 900	41010205.16
1400	1x 1350	41010208.16

Width (mm)	Accessory width (mm)	Order Ref.
1850	2x 900	41010212.16
1850	1x 1800	41010213.16

Rear Frame System

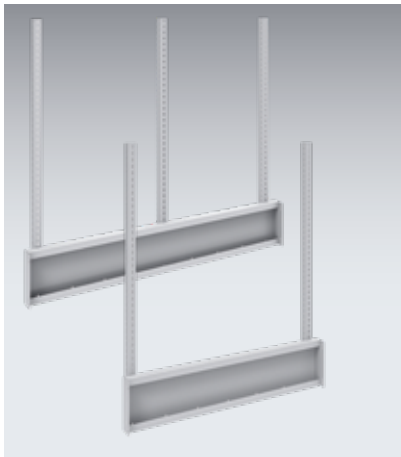

Item	1500 Bench	2000 Bench
	Order Ref.	Order Ref.
Twin upright set for verso framework bench	41010158.16	41010159.16
Triple upright set for verso framework bench	41010160.16	41010161.16
Twin upright set for verso storage bench	41010250.16	41010251.16
Triple upright set for verso storage bench	41010252.16	41010253.16
Additional Upright	41010162.16	41010162.16
Twin short upright set for verso framework bench	41010242.16	41010243.16
Triple short upright set for verso framework bench	41010244.16	41010245.16
Twin short upright set for verso storage bench	41010254.16	41010255.16
Triple short upright set for verso storage bench	41010256.16	41010257.16
Additional short Upright	41010246.16	41010246.16

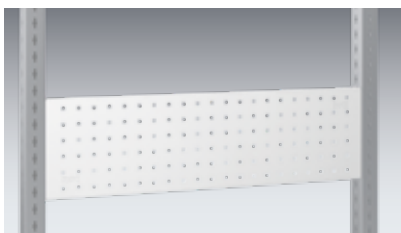

240mm high perfo panel



480mm high louvre panel



Adjustable shelf

Item	450mm Wide	900mm Wide	1350mm Wide	1800mm Wide
	Order Ref.	Order Ref.	Order Ref.	Order Ref.
perfo panel 240mm high	14025340.16	14025341.16	14025342.16	14025343.16
perfo panel 480mm high	14025344.16	14025345.16	14025346.16	14025347.16
Louvre panel 240mm high	14025360.16	14025361.16	14025362.16	14025363.16
Louvre panel 480mm high	14025364.16	14025365.16	14025366.16	14025367.16
Fixed shelf 200mm deep	41010166.16	41010167.16	41010168.16	41010169.16
Adjustable shelf 200mm deep	41010170.16	41010171.16	41010172.16	41010173.16
Adjustable shelf 350mm deep	41010174.16	41010175.16	41010176.16	41010177.16
Bin rail	41011014.16	41011015.16	41011016.16	/

Rear Frame Accessories



LED light and support frame

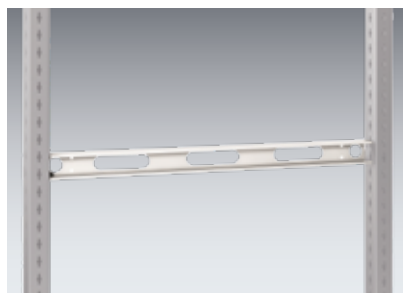

Power rail



Power rail shown with socket outlet strip with FR sockets & switch

Item	450mm Wide	900mm Wide	1350mm Wide	1800mm Wide
	Order Ref.	Order Ref.	Order Ref.	Order Ref.
LED light with support frame	/	41010163.16*	41010164.16	41010165.16
Top brace (for use instead of light)	41011132.16	41011104.16	41011105.16	41011193.16
Power rail	41011250.16	41011251.16	41011252.16	41011253.16
Vertical power rail bracket	41011254.16			
Socket outlet strip with 4 x U.K. sockets & on/off switch	51001128			
Socket outlet strip with 6 x U.K. sockets & on/off switch	51001129			

Choose the correct length / type power rail and then add socket outlet strips to suit your requirements.

The overhead lights are supplied with a 3m cable and U.K plug. Socket outlet strips are supplied with a 1.8m U.K. plug.

Please ensure all necessary regulations are adhered to for your application. * - Note the LED light is wider than the 900mm wide frame.



Monitor bracket

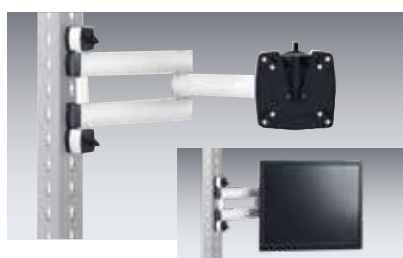

Monitor bracket & arm



Swivel arm & tray

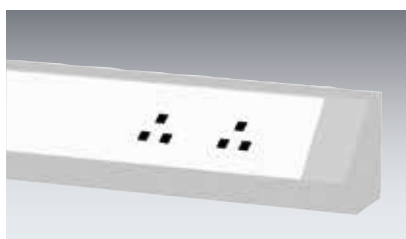

Service duct

Item	Order Ref.
Monitor bracket (VESA 75/100)	41011086
Monitor arm & bracket (VESA 75/100)	41011087
Swivel arm & tray	41011061.20
Service duct with 4 x UK sockets and 3m cable & UK plug (1500mm)	11042235
Service duct with 4 x UK sockets and 3m cable & UK plug (2000mm)	11042236

Housing:

RAL 7035 – light grey

Fronts:

.19 RAL 7016 – anthracite grey

.11 RAL 5010 – gentian blue

.16 RAL 7035 – light grey

.24 RAL 3004 – crimson red

cupboards

mobile

benches

accessories

perfo

CNC

cupboards

mobile

benches

accessories

facilities

cases

seating

bott

Our main Workplace Storage Equipment catalogue showing our full range is available to download from our website.



For more information please contact your local dealer:

To confirm current prices please contact your dealer; or bott on:
Tel: 01288 357788 Email: i-sales@bott.com Web: www.bottltd.co.uk